

COMUNICADORES

DSC NEO HS2016 con GT/GT+/GET configuración rápida



GT product image

GT



GT+ product image

GT+



GET product image

GET

Pasos breves de cableado y programación para conectar el comunicador GT/GT+/GET al panel DSC NEO HS2016 usando terminales TIP/RING, y luego añadir el sistema a Protegus2. Use esto junto con los manuales completos para otros ajustes. (Las etiquetas de terminal pueden variar ligeramente entre GT/GT+/GET, pero las conexiones son las mismas.)



PRECAUCIÓN

La instalación y el servicio deben ser realizados solo por personal cualificado. Desconecte la alimentación antes de cablear. Los cambios no autorizados anulan la garantía.

1. Requisitos

1. Firmware GT/GT+/GET 1.21, SIM insertada, PIN deshabilitado, plan de datos activo.
2. Panel DSC NEO HS2016 con acceso al teclado (código de instalador disponible).
3. Número de cuenta CMS si reporta a CMS.
4. Cuenta de empresa/instalador de Protegus2 y IMEI del comunicador.

2. Cableado

Cookie consent

We use cookies to measure the effectiveness of our documentation and whether users find what they're searching for. With your consent, you're helping us to make our documentation better.



Google Analytics

Accept

Reject

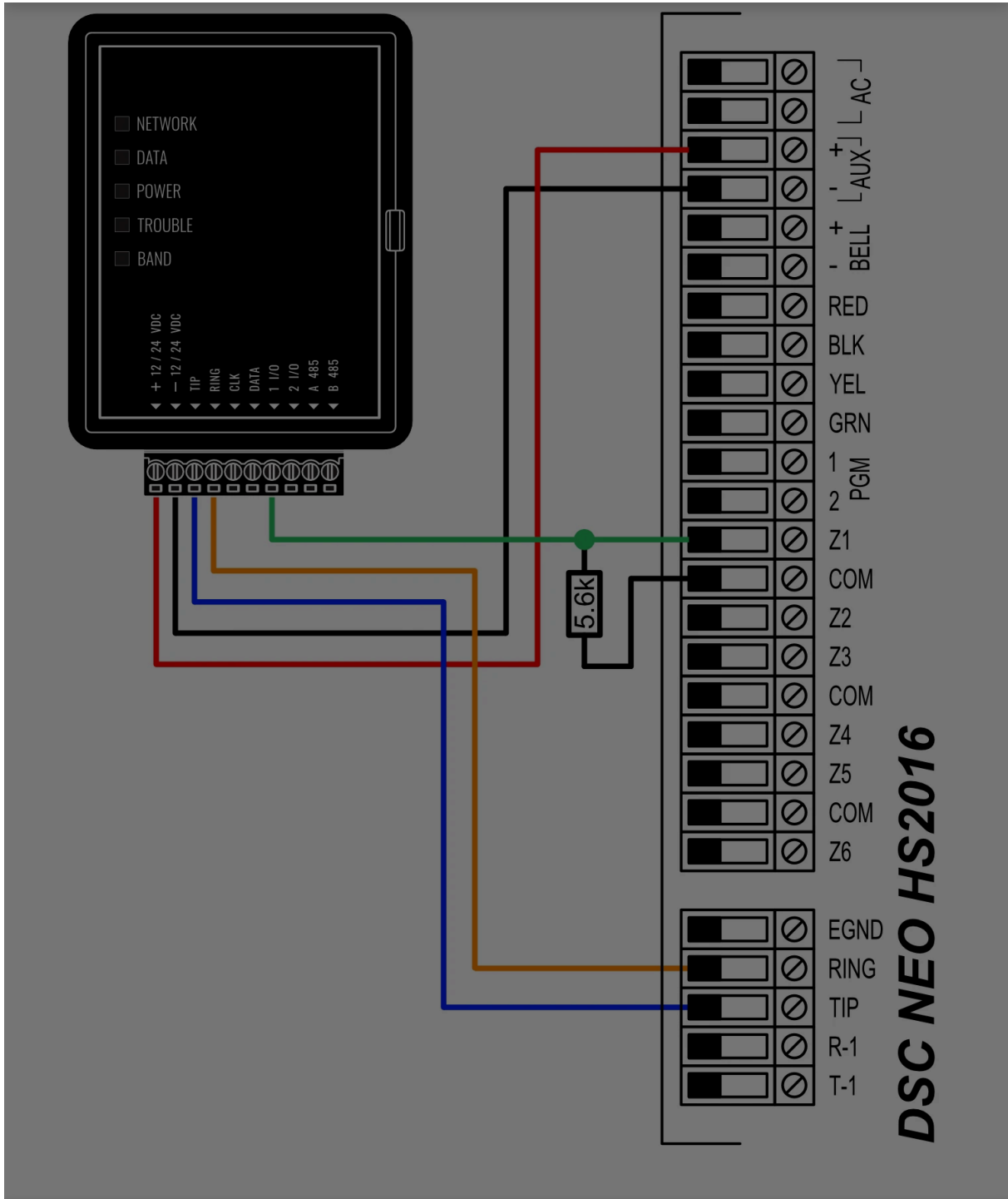

Cookie consent

We use cookies to measure the effectiveness of our documentation and whether users find what they're searching for. With your consent, you're helping us to make our documentation better.

- Google Analytics





Entrada de teclado	Descripción de la acción
*85555	Entrar en modo de programación
001*	Entrar en programación de "Zone type"
066##	Configurar el tipo de zona "Momentary keyswitch"
301*	Entrar en programación de "Phone Number"
<1234##	Introducir número telefónico (1234)
310*	Entrar en programación de "Account Codes"
1111	Introducir "System Account Code" (1111)
001	
2222#	Introducir "Partition 1 Account Code" (2222)
311	Entrar en programación de "Partition 1 Call Direction"
003*##	Habilitar "Partition Opening/Closing Call Direction" (Y)
350*	Entrar en programación de "Communicator Formats"
03#	03 - Formato Contact ID.
##	Salir del modo de programación.

4. Añadir sistema a Protegus2

Paso 1. Pulse **Agregar nuevo sistema.**

Cookie consent

We use cookies to measure the effectiveness of our documentation and whether users find what they're searching for. With your consent, you're helping us to make our documentation better.

Google Analytics

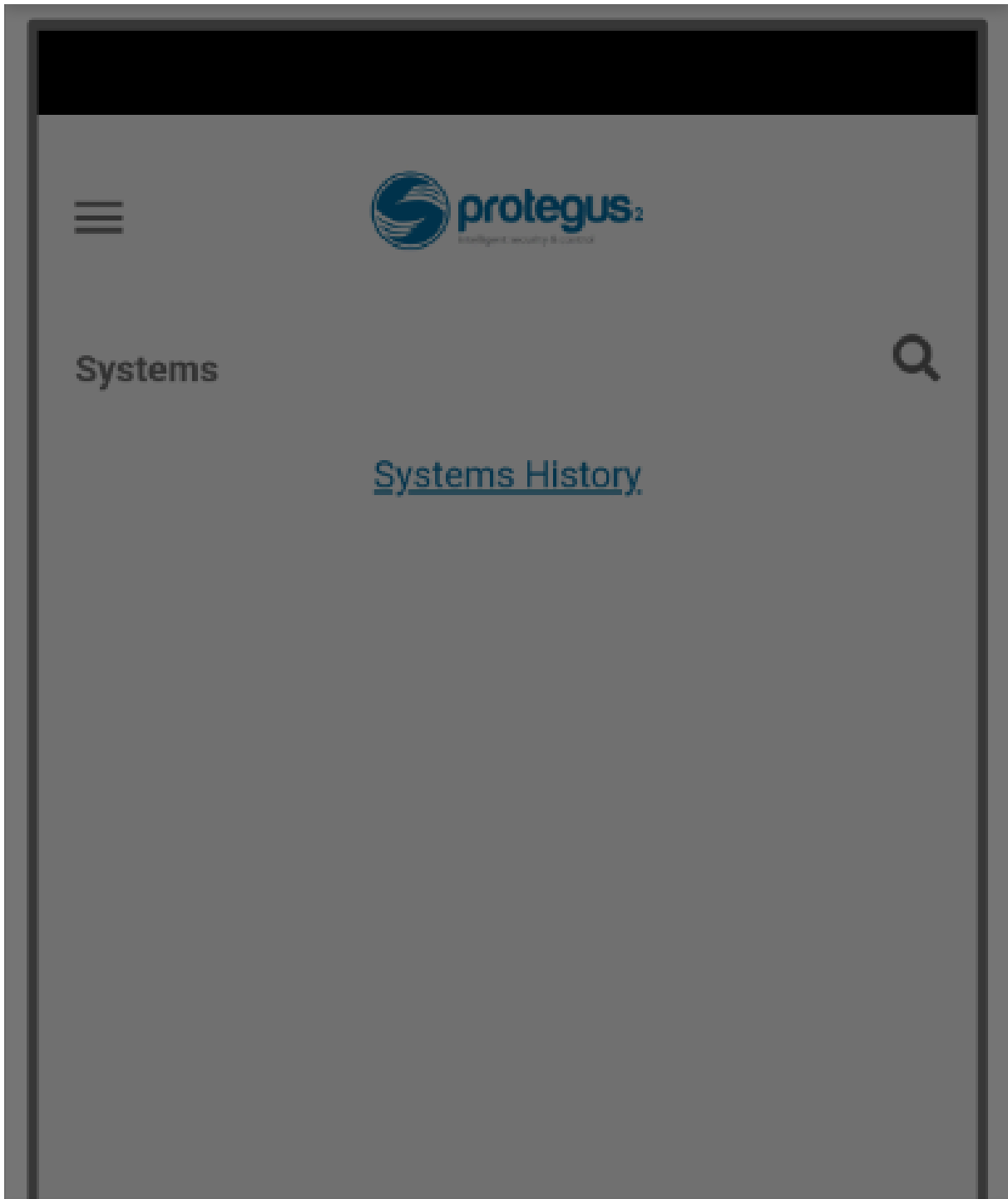

Cookie consent

We use cookies to measure the effectiveness of our documentation and whether users find what they're searching for. With your consent, you're helping us to make our documentation better.

Google Analytics





Paso 2. Introduzca el **IMEI** del comunicador, pulse **Siguiente**.

Cookie consent

We use cookies to measure the effectiveness of our documentation and whether users find what they're searching for. With your consent, you're helping us to make our documentation better.

Google Analytics



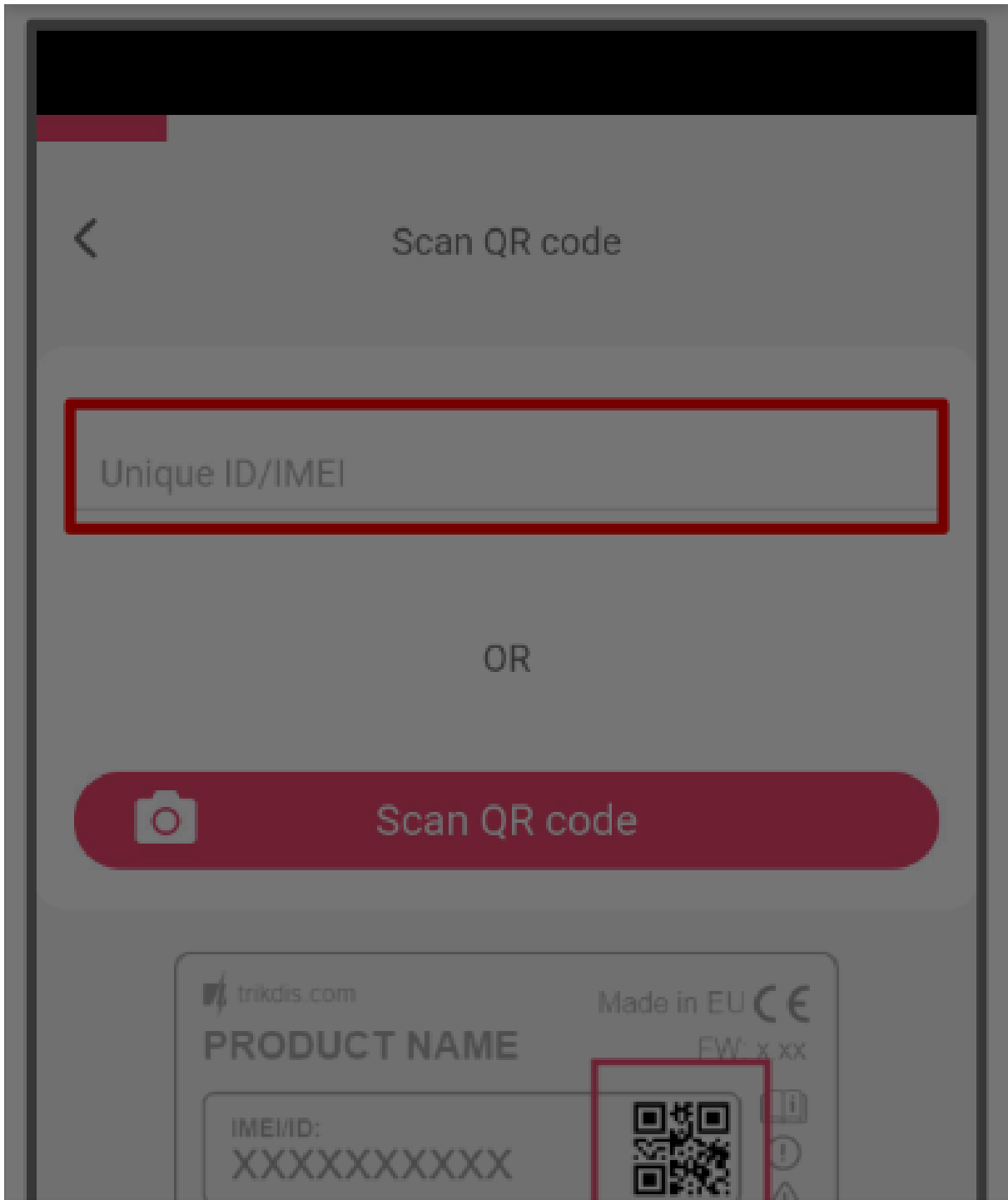

Cookie consent

We use cookies to measure the effectiveness of our documentation and whether users find what they're searching for. With your consent, you're helping us to make our documentation better.

Google Analytics



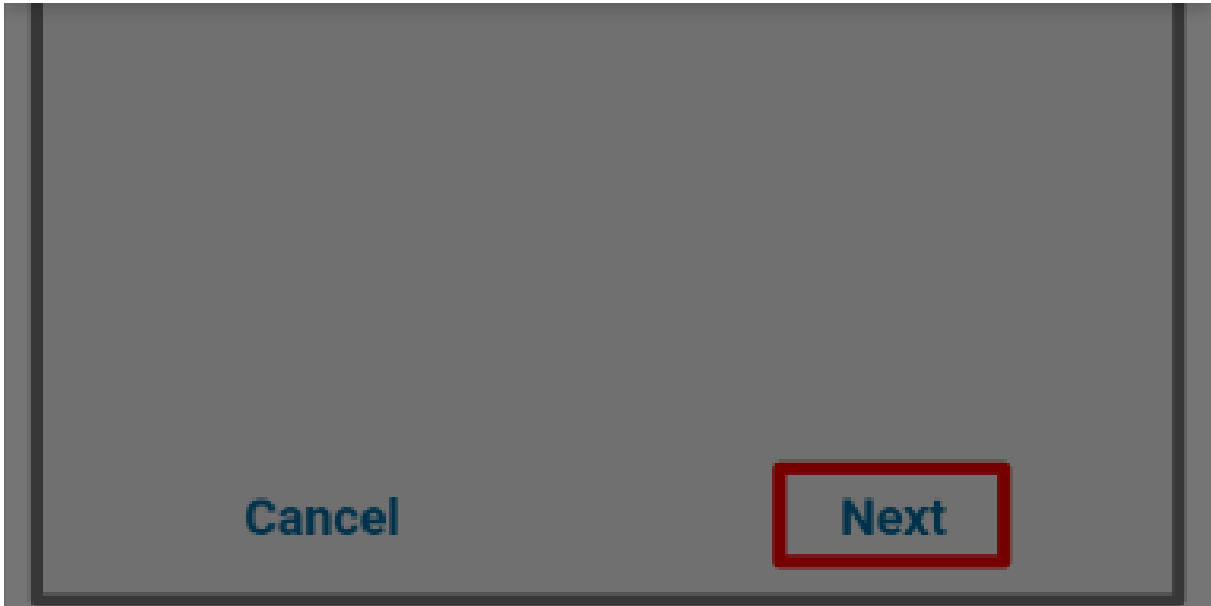

Paso 3. Seleccione la empresa de seguridad.

Cookie consent

We use cookies to measure the effectiveness of our documentation and whether users find what they're searching for. With your consent, you're helping us to make our documentation better.

Google Analytics



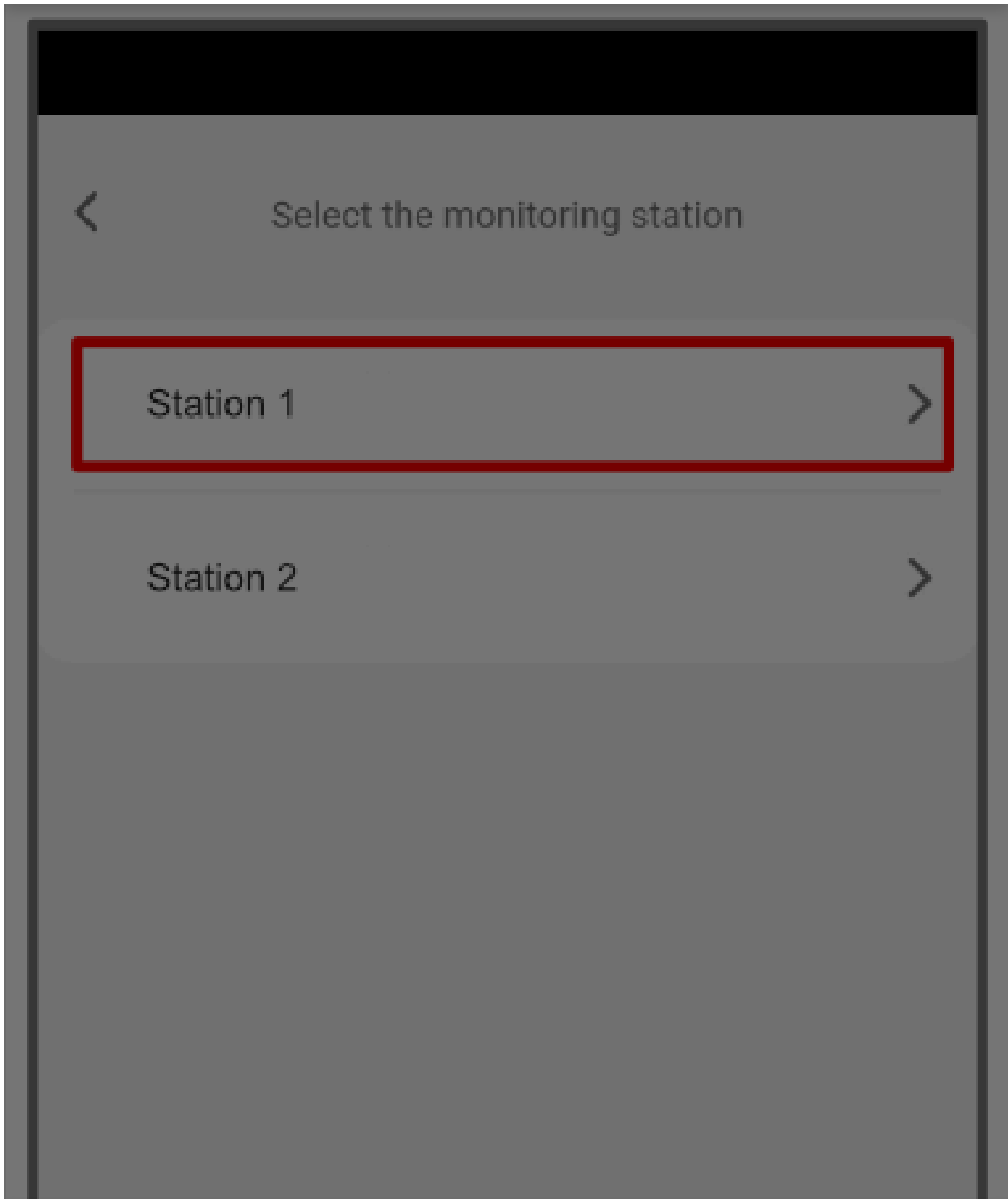

Cookie consent

We use cookies to measure the effectiveness of our documentation and whether users find what they're searching for. With your consent, you're helping us to make our documentation better.

Google Analytics





Cancel

Add only to Protegus2

Paso 4. Elija TIP RING.

Cookie consent

We use cookies to measure the effectiveness of our documentation and whether users find what they're searching for. With your consent, you're helping us to make our documentation better.

Google Analytics



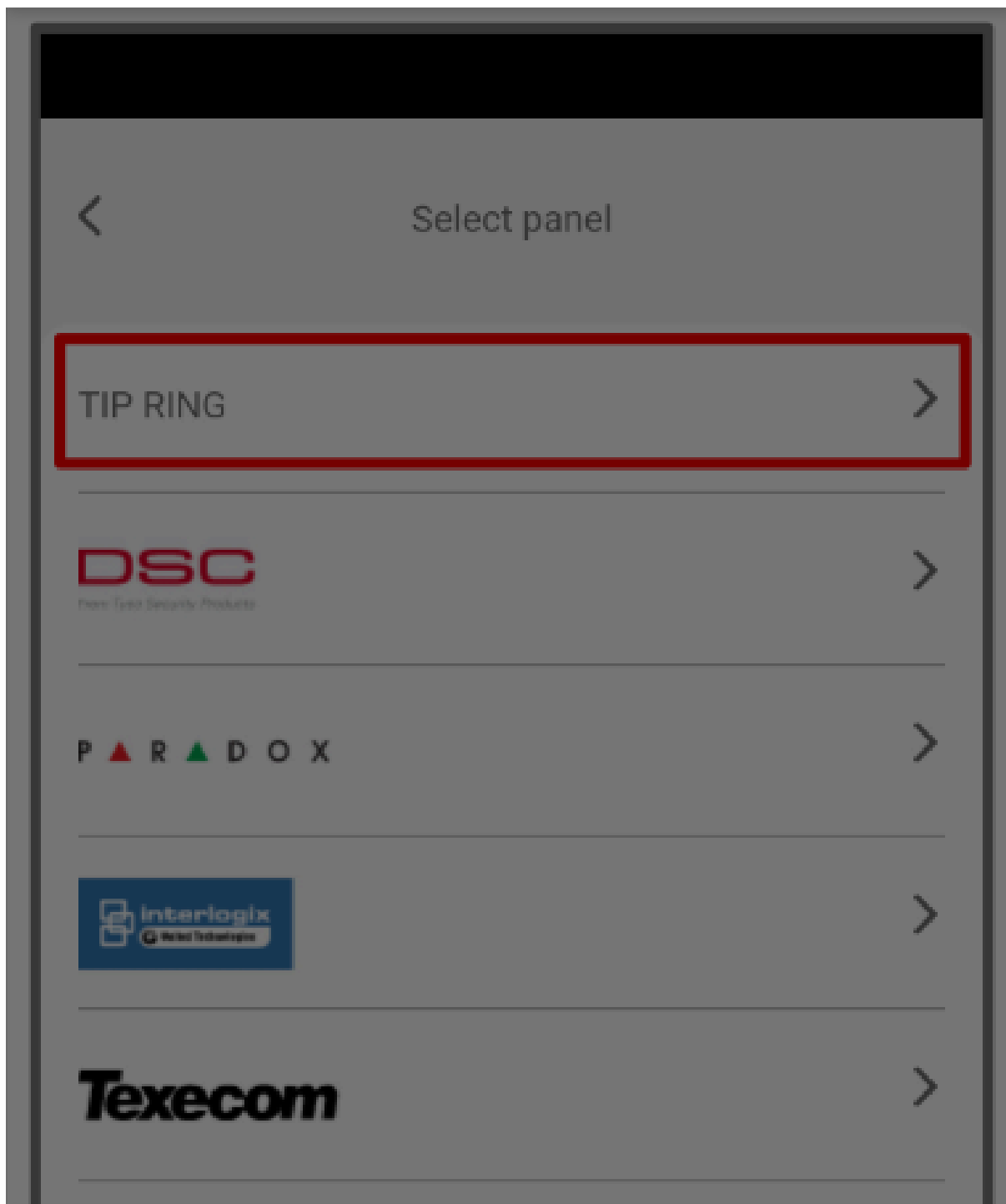

Cookie consent

We use cookies to measure the effectiveness of our documentation and whether users find what they're searching for. With your consent, you're helping us to make our documentation better.

Google Analytics





Cancel

Paso 5. Elija Mode.

Cookie consent

We use cookies to measure the effectiveness of our documentation and whether users find what they're searching for. With your consent, you're helping us to make our documentation better.

Google Analytics



Cookie consent

We use cookies to measure the effectiveness of our documentation and whether users find what they're searching for. With your consent, you're helping us to make our documentation better.

Google Analytics





Cancel

Next

Paso 6. Elija AUTO.

Cookie consent

We use cookies to measure the effectiveness of our documentation and whether users find what they're searching for. With your consent, you're helping us to make our documentation better.

Google Analytics



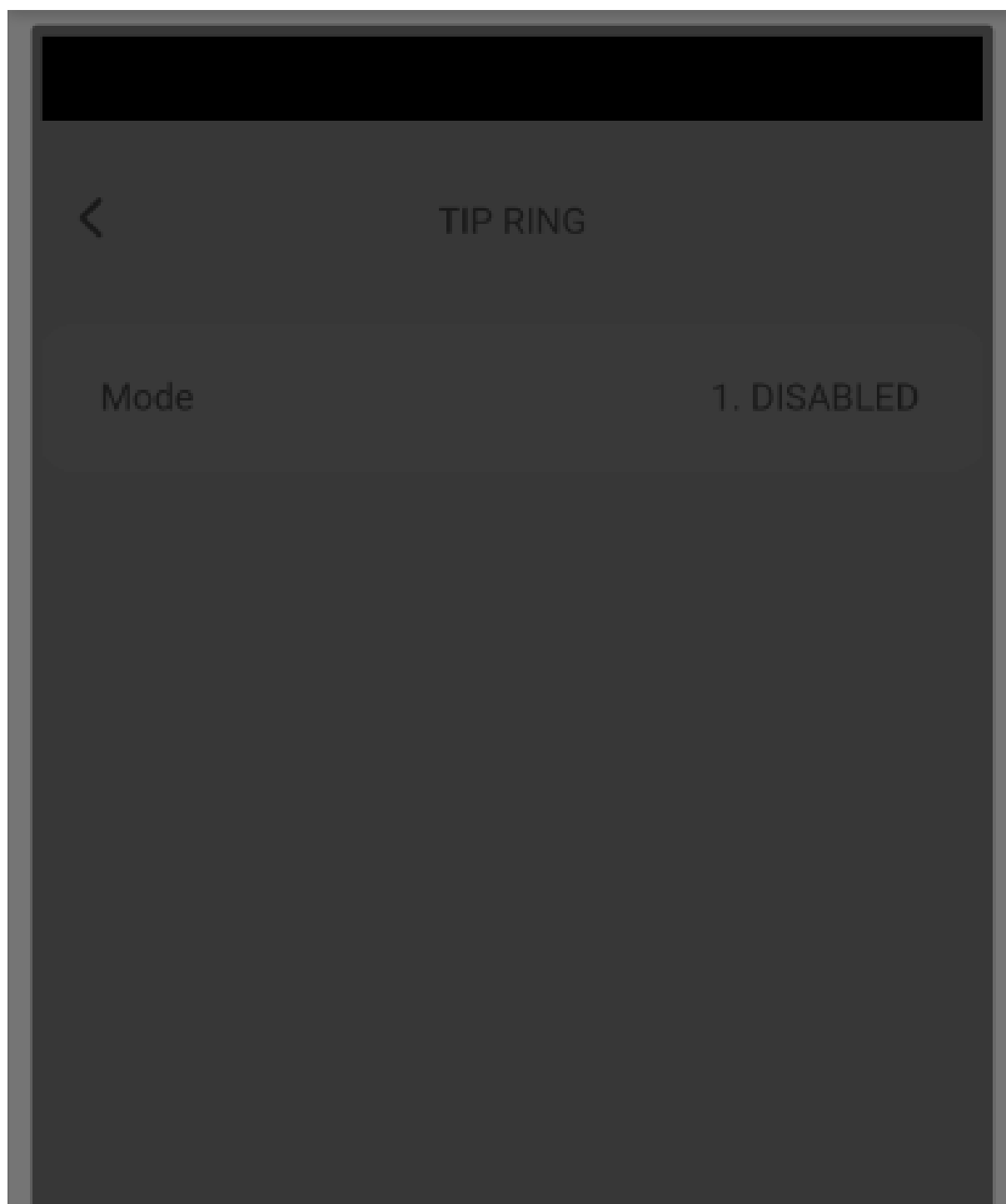

Cookie consent

We use cookies to measure the effectiveness of our documentation and whether users find what they're searching for. With your consent, you're helping us to make our documentation better.

Google Analytics





Mode

1. DISABLED

2. AUTO

3. MANUAL

Paso 7. Pulse **Siguiente**.

Cookie consent

We use cookies to measure the effectiveness of our documentation and whether users find what they're searching for. With your consent, you're helping us to make our documentation better.

Google Analytics

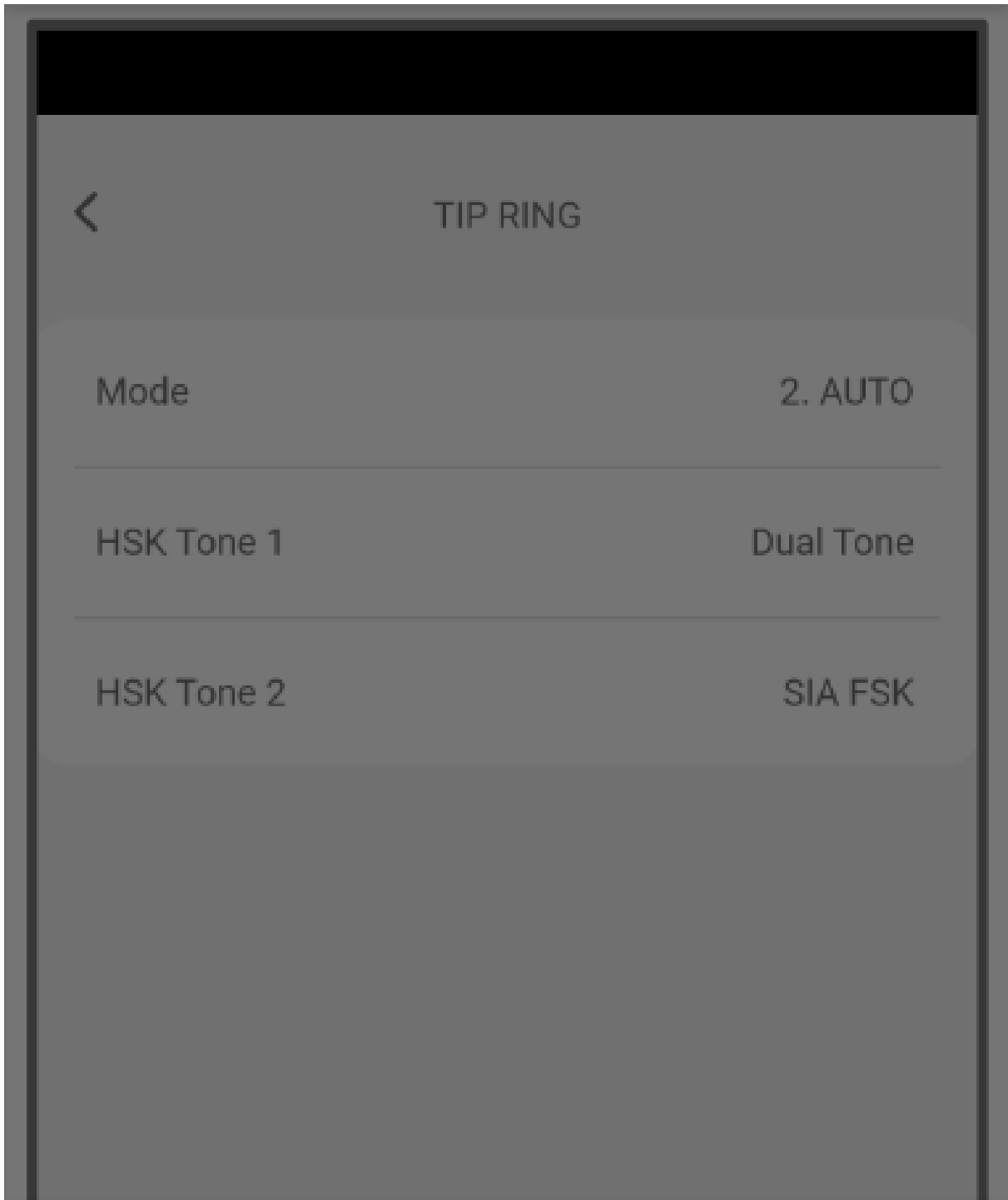

Cookie consent

We use cookies to measure the effectiveness of our documentation and whether users find what they're searching for. With your consent, you're helping us to make our documentation better.

Google Analytics





Cancel

Next

Paso 8. Introduzca **Object ID** y **Module ID**, pulse **Siguiente**.

Cookie consent

We use cookies to measure the effectiveness of our documentation and whether users find what they're searching for. With your consent, you're helping us to make our documentation better.

Google Analytics



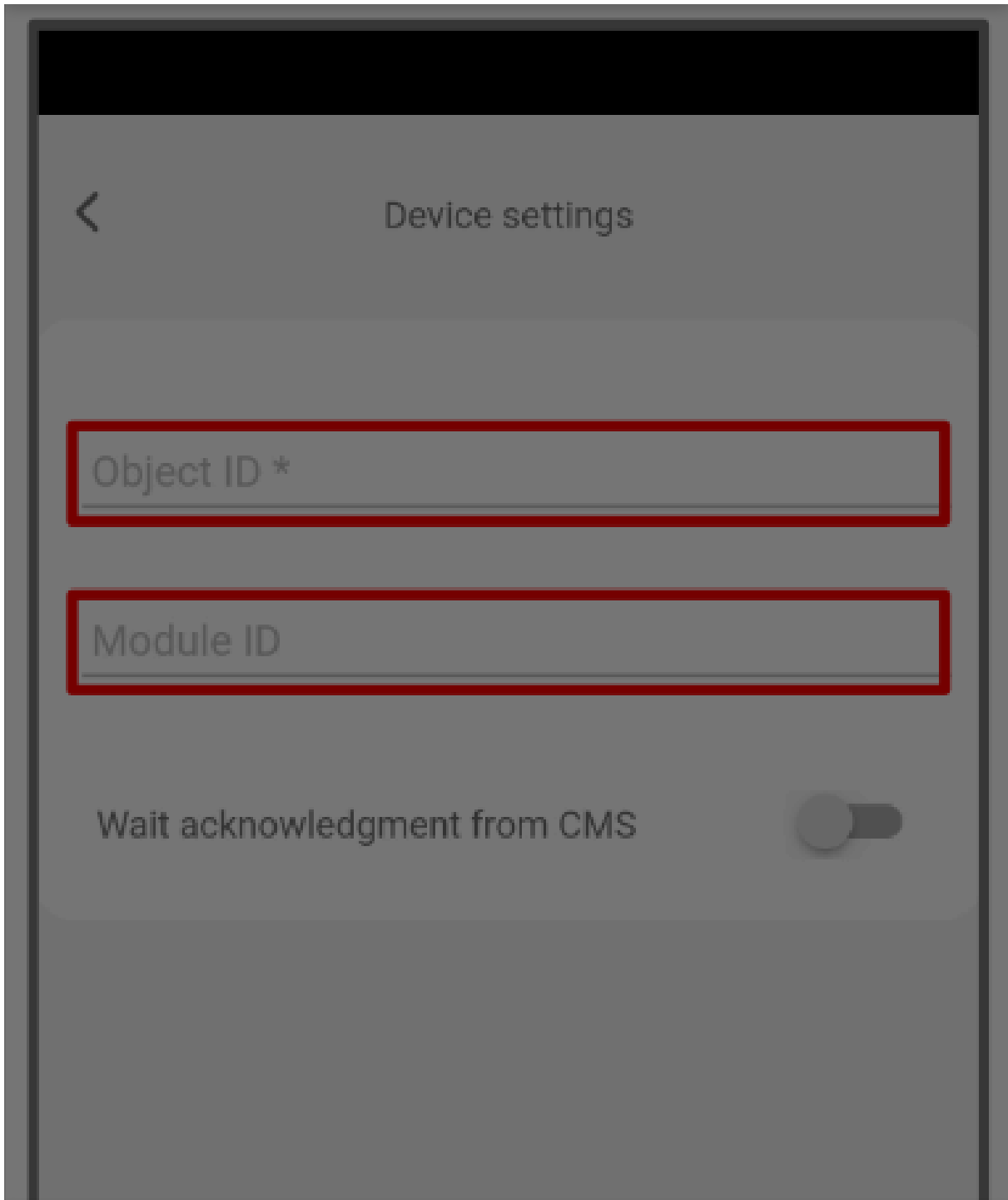

Cookie consent

We use cookies to measure the effectiveness of our documentation and whether users find what they're searching for. With your consent, you're helping us to make our documentation better.

Google Analytics



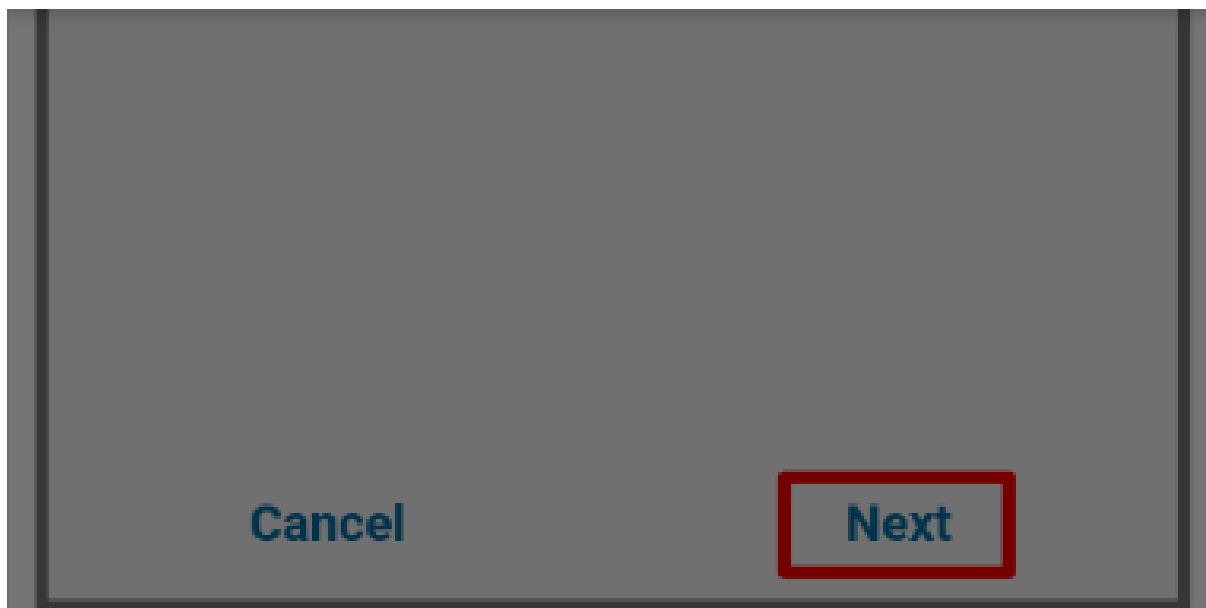

Paso 9. Espere mientras se escriben los datos.

Cookie consent

We use cookies to measure the effectiveness of our documentation and whether users find what they're searching for. With your consent, you're helping us to make our documentation better.

Google Analytics

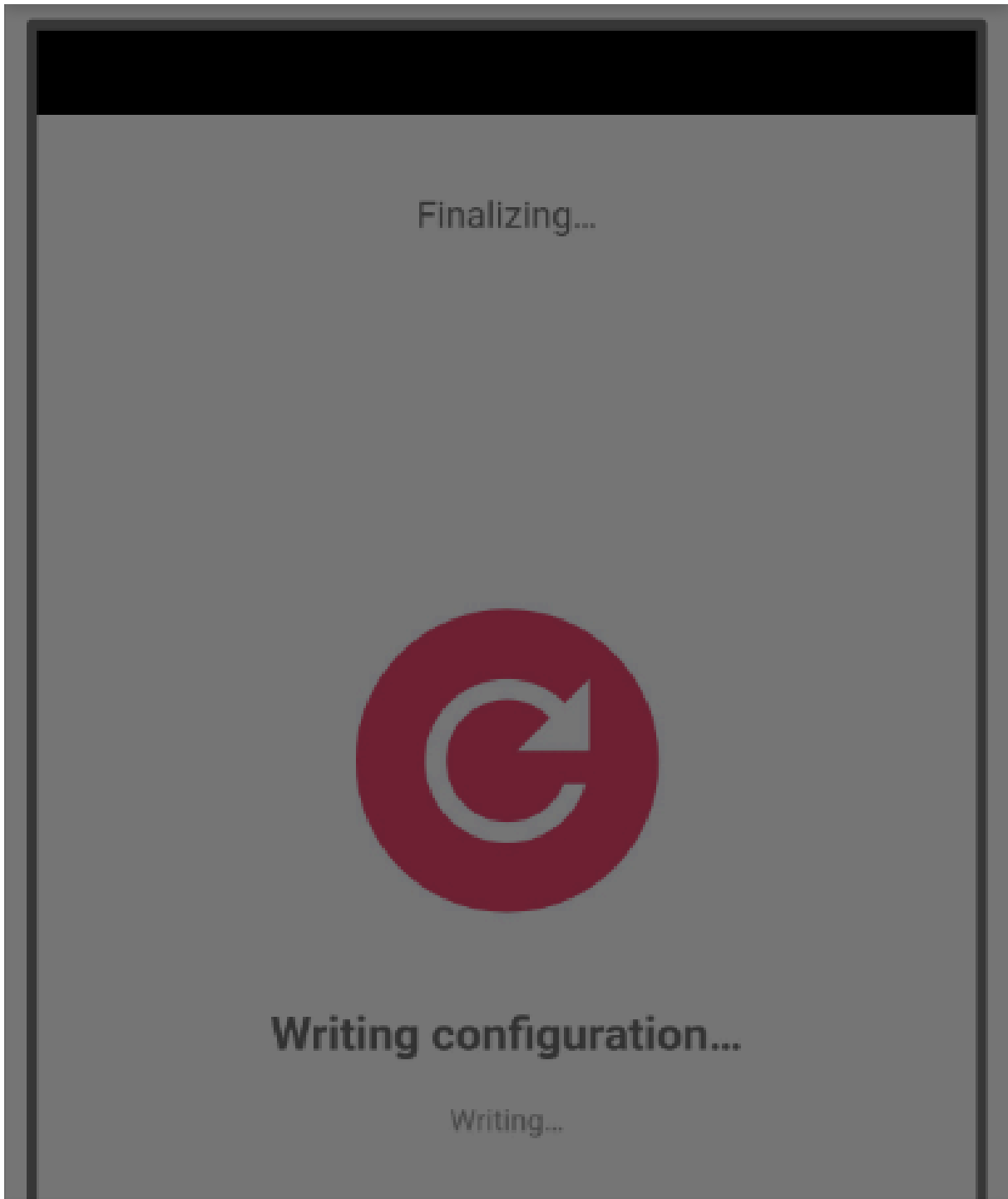

Cookie consent

We use cookies to measure the effectiveness of our documentation and whether users find what they're searching for. With your consent, you're helping us to make our documentation better.

Google Analytics





Cancel

Paso 10. Pulse **Agregar a Protegus2**.

Cookie consent

We use cookies to measure the effectiveness of our documentation and whether users find what they're searching for. With your consent, you're helping us to make our documentation better.

Google Analytics



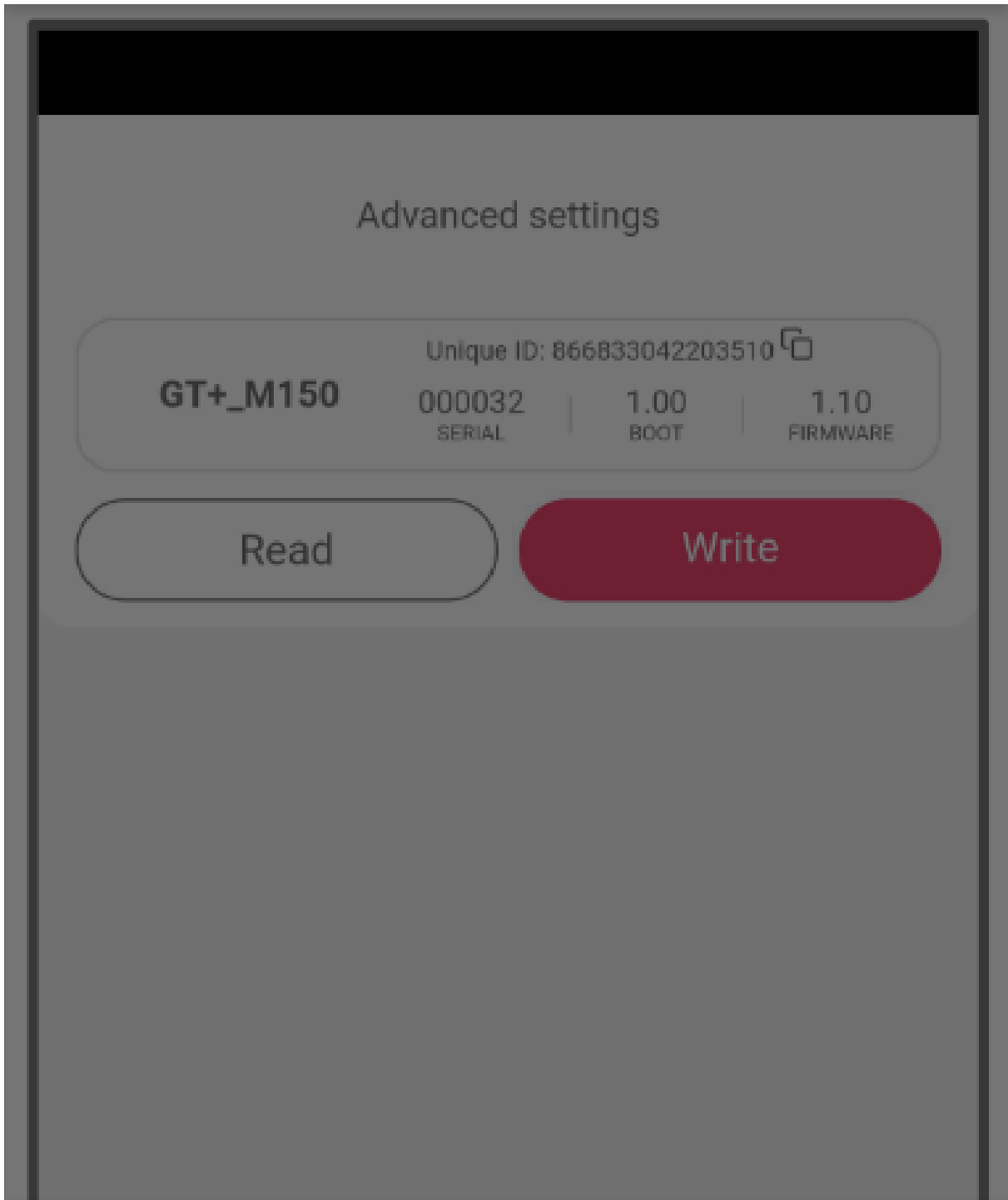

Cookie consent

We use cookies to measure the effectiveness of our documentation and whether users find what they're searching for. With your consent, you're helping us to make our documentation better.

Google Analytics

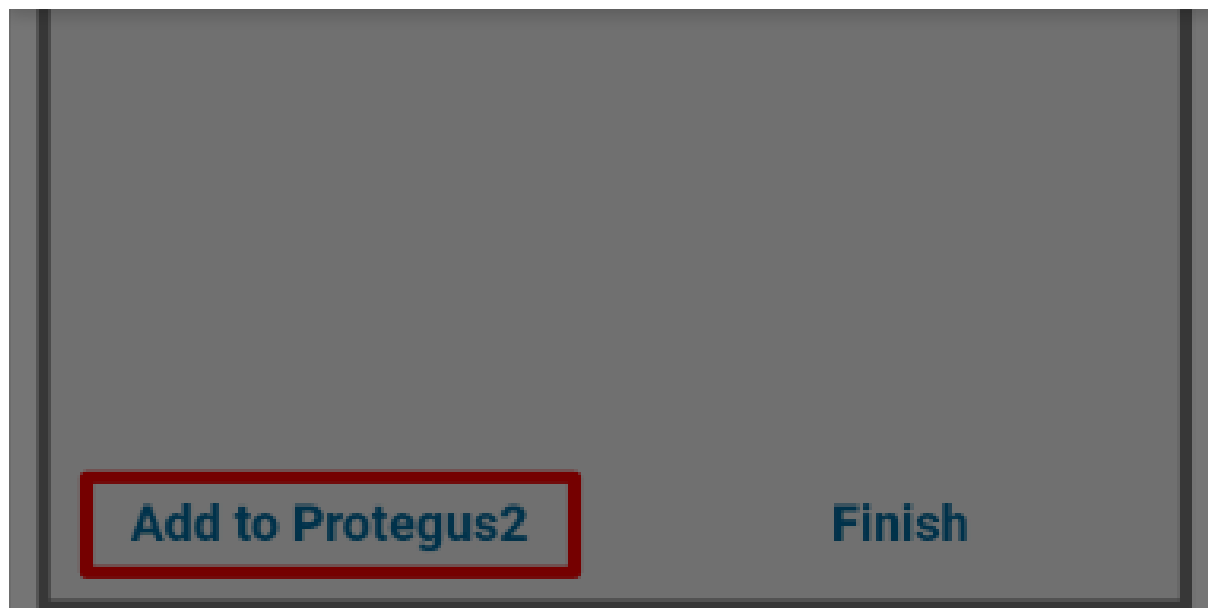

Paso 11. Introduzca el **Nombre** del sistema, pulse **Siguiente**.

Cookie consent

We use cookies to measure the effectiveness of our documentation and whether users find what they're searching for. With your consent, you're helping us to make our documentation better.

Google Analytics





Add new system

Name
GT+ NEO HS2016

Background 

Time zone
Europe/Vilnius 

Cookie consent

We use cookies to measure the effectiveness of our documentation and whether users find what they're searching for. With your consent, you're helping us to make our documentation better.

Google Analytics

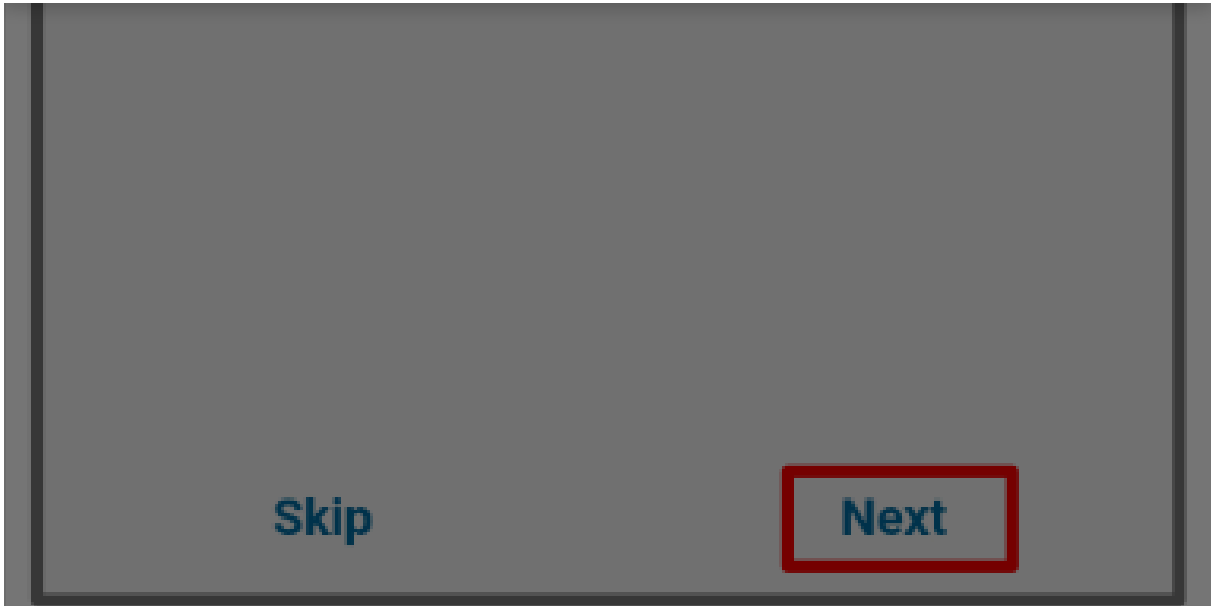

Paso 12. Pulse **Continuar**.

Cookie consent

We use cookies to measure the effectiveness of our documentation and whether users find what they're searching for. With your consent, you're helping us to make our documentation better.

Google Analytics



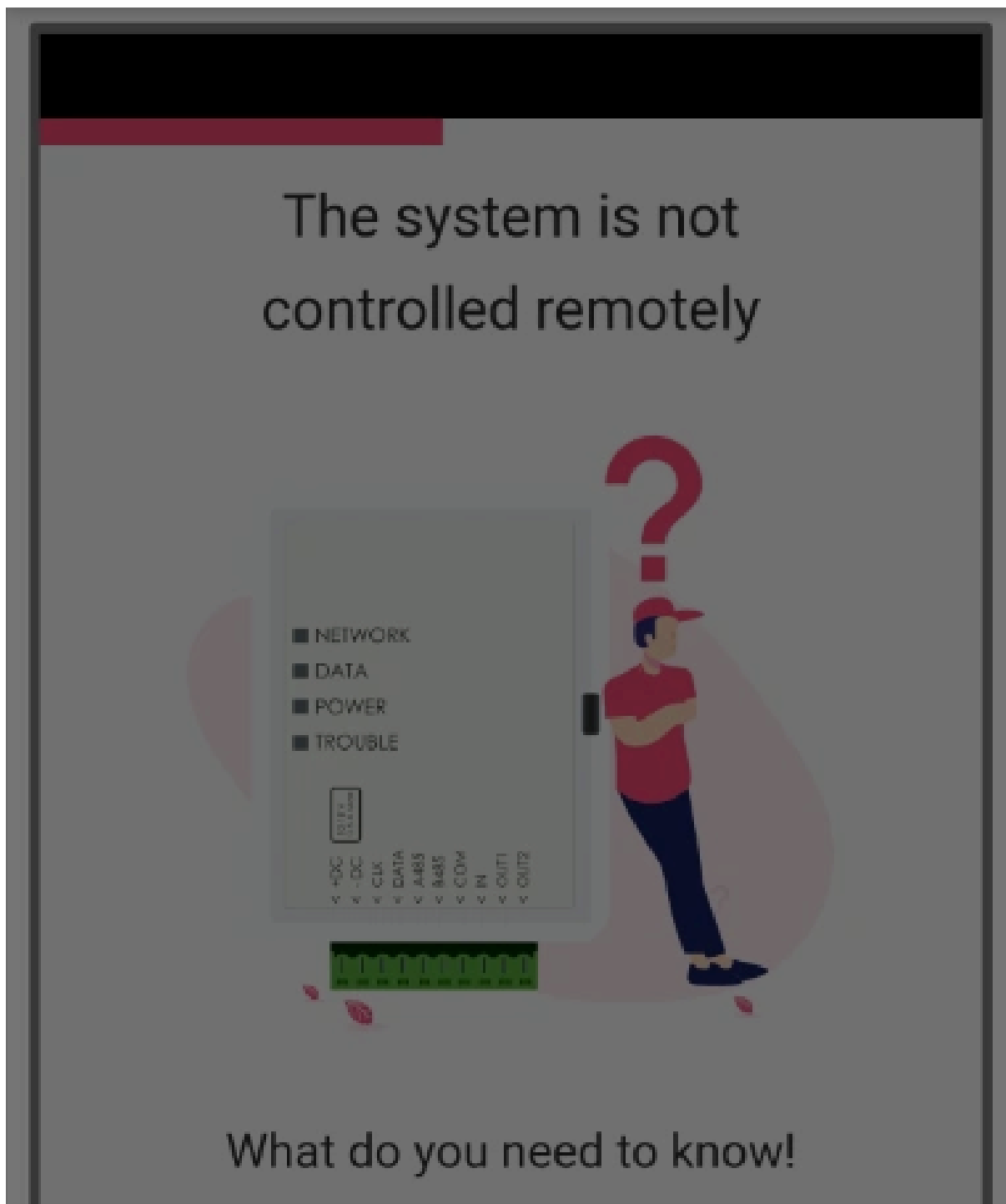

Cookie consent

We use cookies to measure the effectiveness of our documentation and whether users find what they're searching for. With your consent, you're helping us to make our documentation better.

- Google Analytics



Continue

Paso 13. Introduzca el **Nombre del área**. Habilite **Control con Protegus2**.

Cookie consent

We use cookies to measure the effectiveness of our documentation and whether users find what they're searching for. With your consent, you're helping us to make our documentation better.

Google Analytics

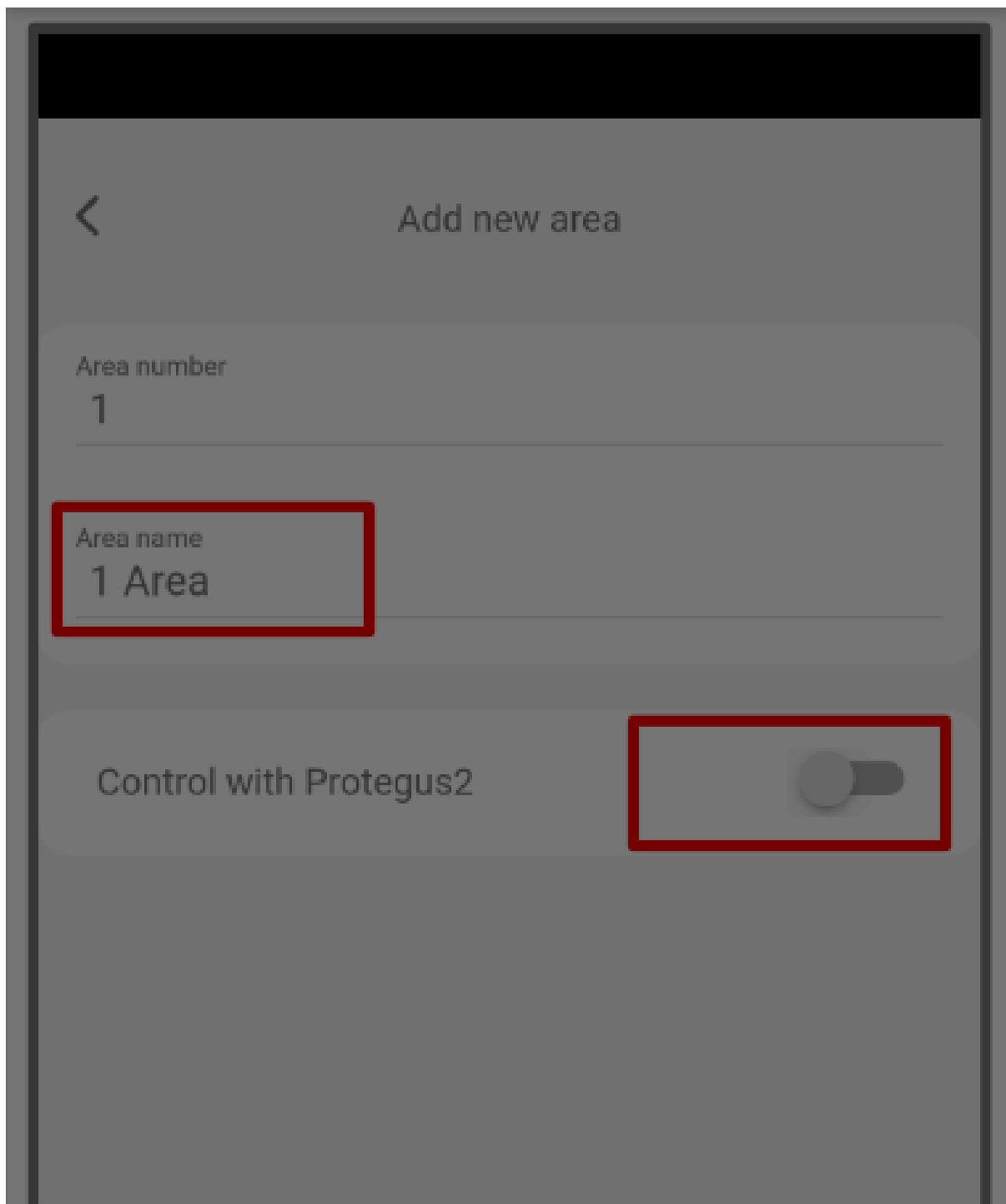

Cookie consent

We use cookies to measure the effectiveness of our documentation and whether users find what they're searching for. With your consent, you're helping us to make our documentation better.

Google Analytics





Cancel

Save

Paso 14. Elija la salida PGM. Pulse **Guardar**.

Cookie consent

We use cookies to measure the effectiveness of our documentation and whether users find what they're searching for. With your consent, you're helping us to make our documentation better.

Google Analytics



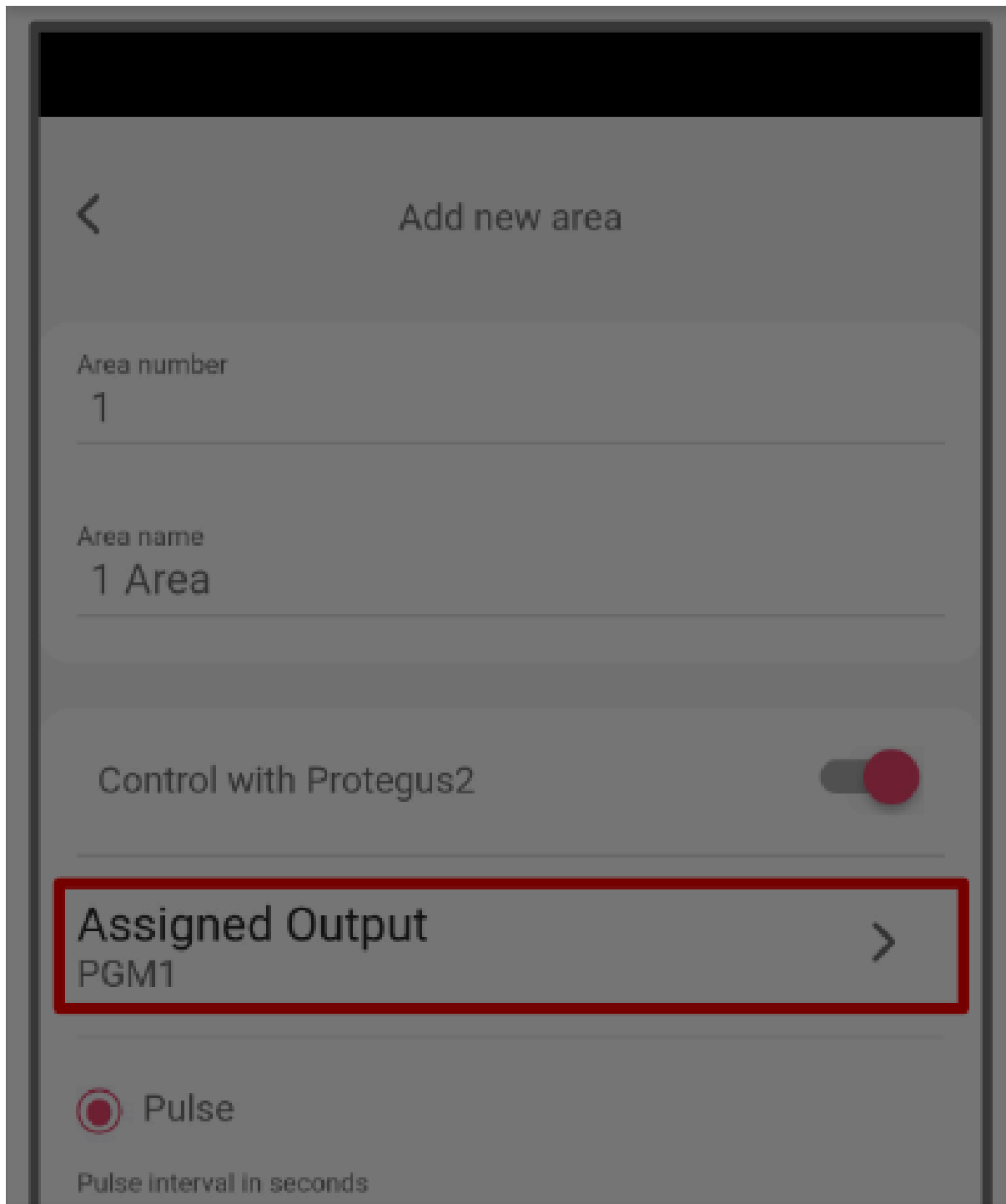

Cookie consent

We use cookies to measure the effectiveness of our documentation and whether users find what they're searching for. With your consent, you're helping us to make our documentation better.

Google Analytics

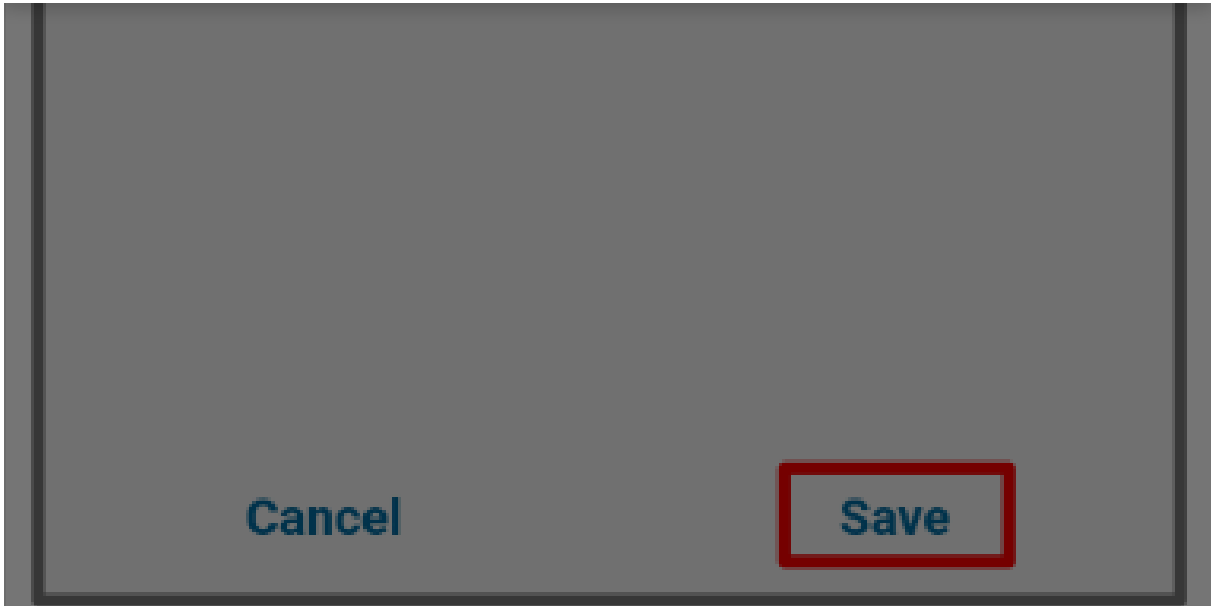

Paso 15. Pulse **Siguiente**.

Cookie consent

We use cookies to measure the effectiveness of our documentation and whether users find what they're searching for. With your consent, you're helping us to make our documentation better.

Google Analytics



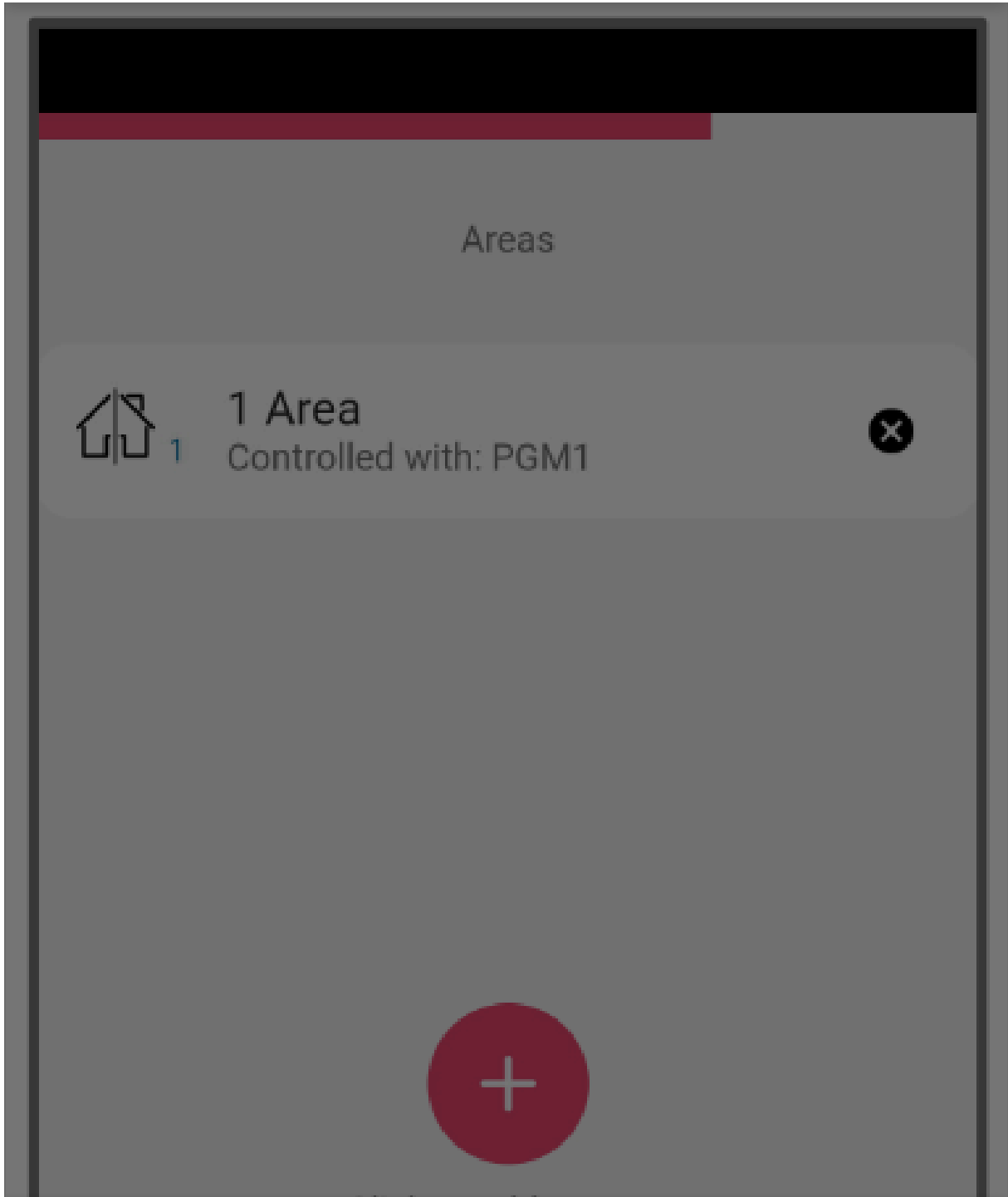

Cookie consent

We use cookies to measure the effectiveness of our documentation and whether users find what they're searching for. With your consent, you're helping us to make our documentation better.

- Google Analytics



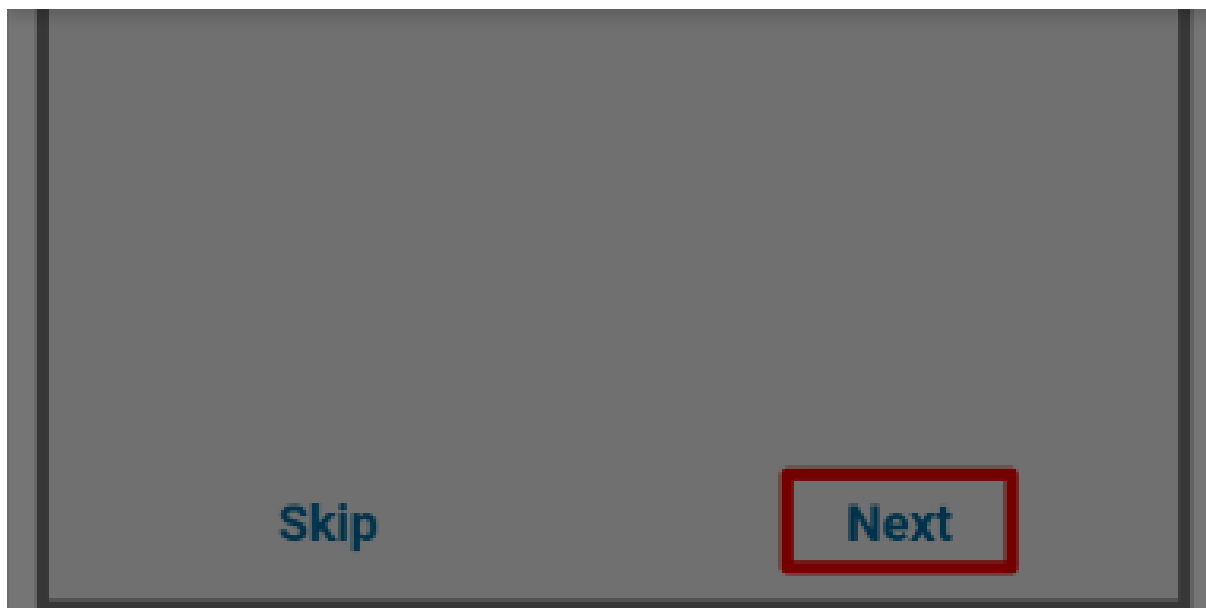

Paso 16. Pulse **Agregar**.

Cookie consent

We use cookies to measure the effectiveness of our documentation and whether users find what they're searching for. With your consent, you're helping us to make our documentation better.

Google Analytics



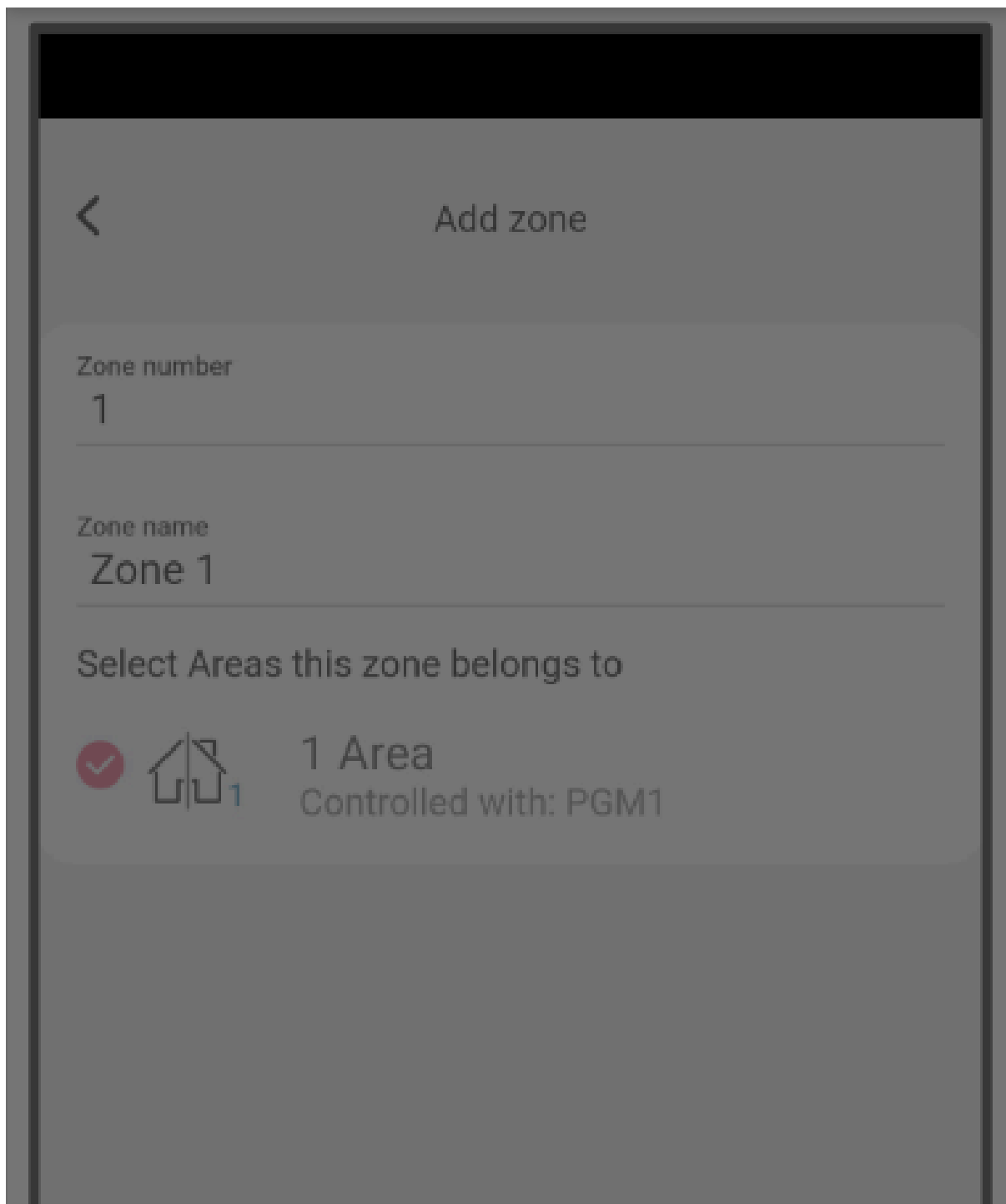

Cookie consent

We use cookies to measure the effectiveness of our documentation and whether users find what they're searching for. With your consent, you're helping us to make our documentation better.

Google Analytics

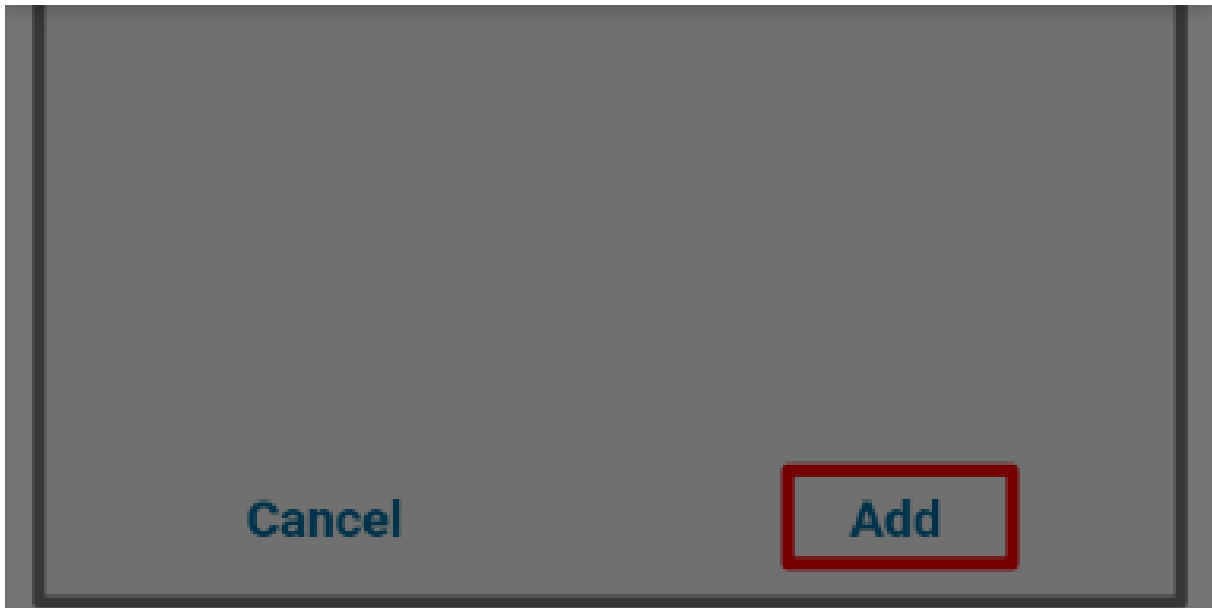

Paso 17. Pulse **Hecho**.

Cookie consent

We use cookies to measure the effectiveness of our documentation and whether users find what they're searching for. With your consent, you're helping us to make our documentation better.

Google Analytics



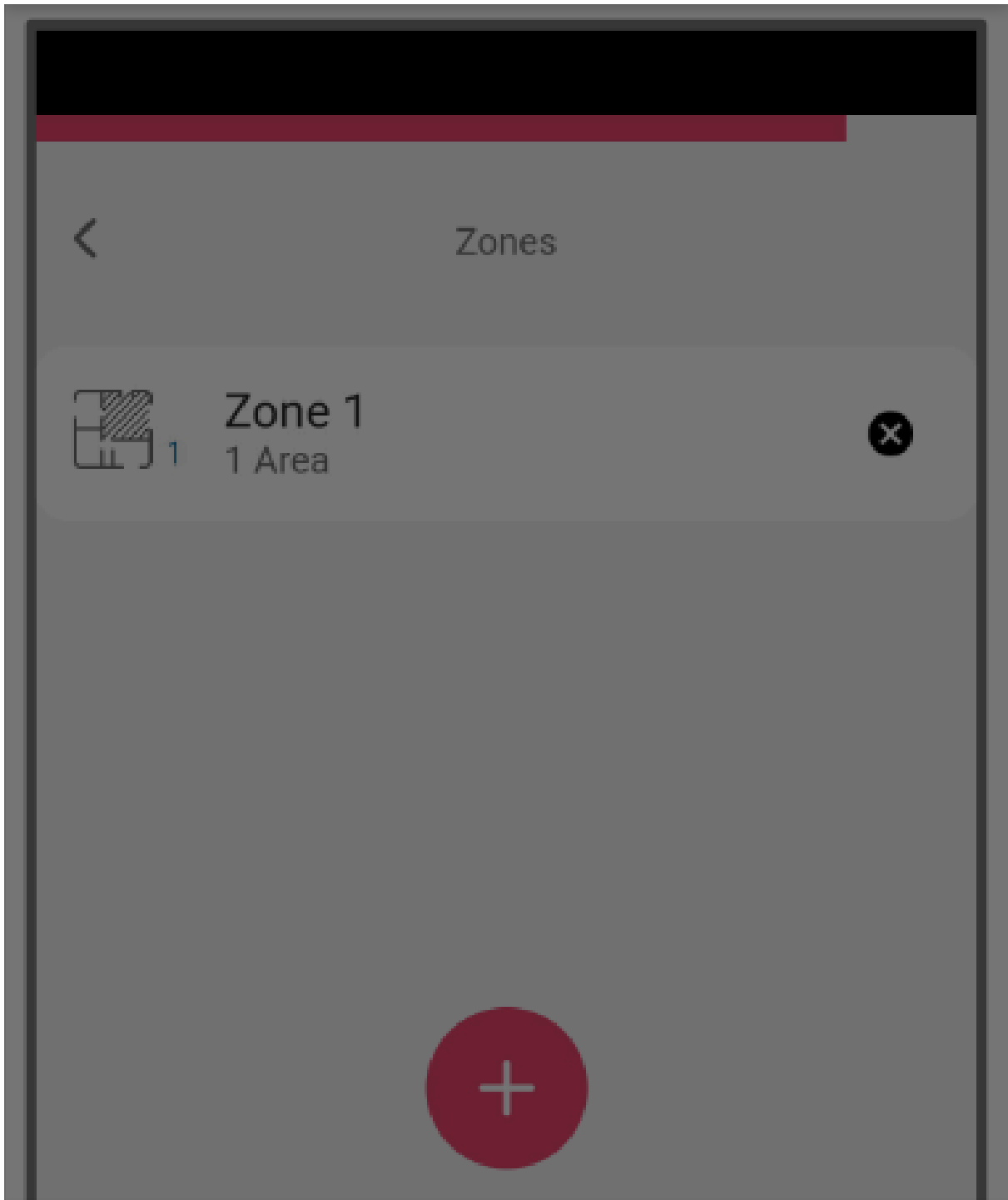

Cookie consent

We use cookies to measure the effectiveness of our documentation and whether users find what they're searching for. With your consent, you're helping us to make our documentation better.

Google Analytics



Done

Paso 18. Pulse **Finalizar**.

Cookie consent

We use cookies to measure the effectiveness of our documentation and whether users find what they're searching for. With your consent, you're helping us to make our documentation better.

Google Analytics



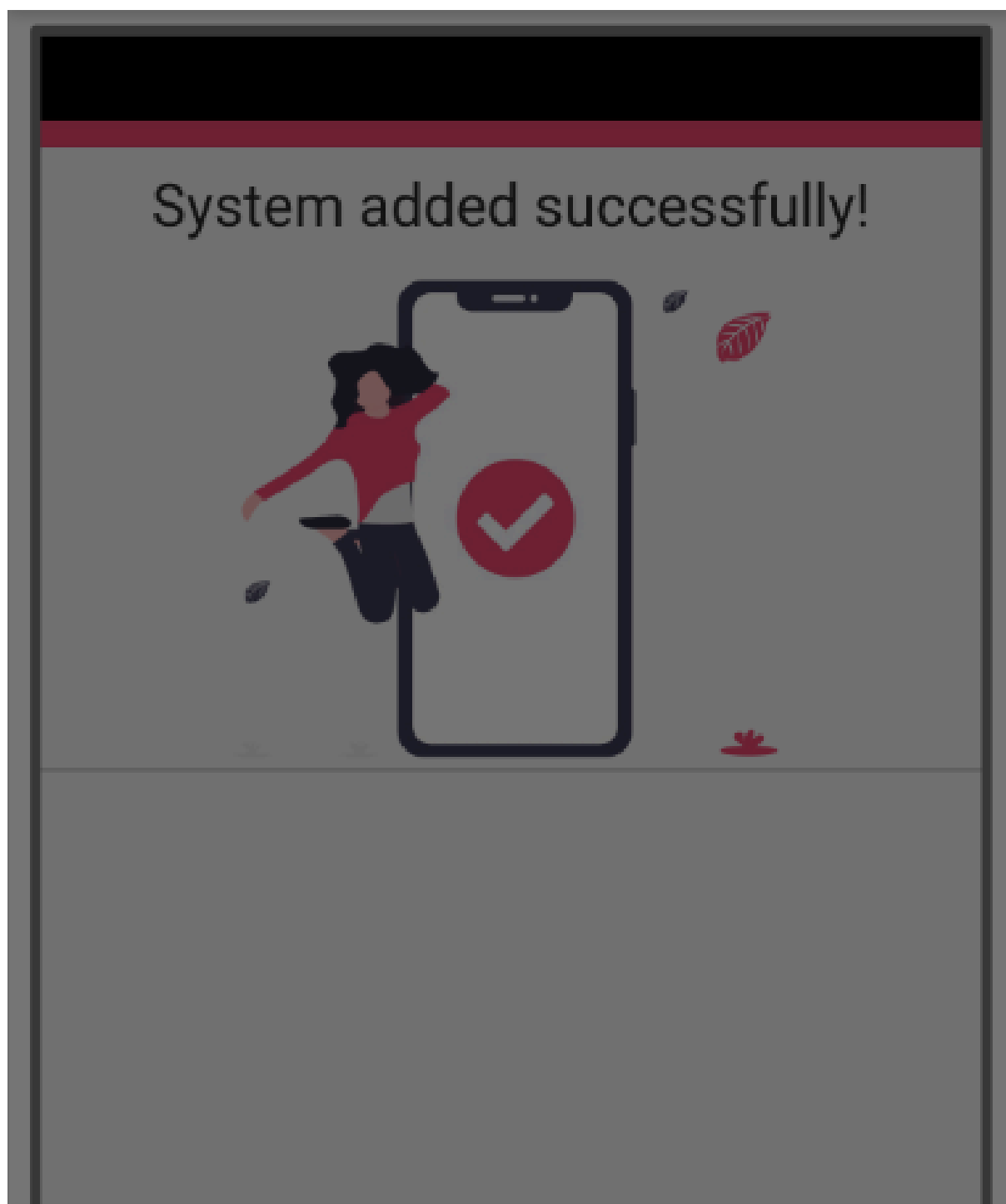

Cookie consent

We use cookies to measure the effectiveness of our documentation and whether users find what they're searching for. With your consent, you're helping us to make our documentation better.

Google Analytics





Finish

Paso 19. Pulse sobre el sistema.

Cookie consent

We use cookies to measure the effectiveness of our documentation and whether users find what they're searching for. With your consent, you're helping us to make our documentation better.

Google Analytics



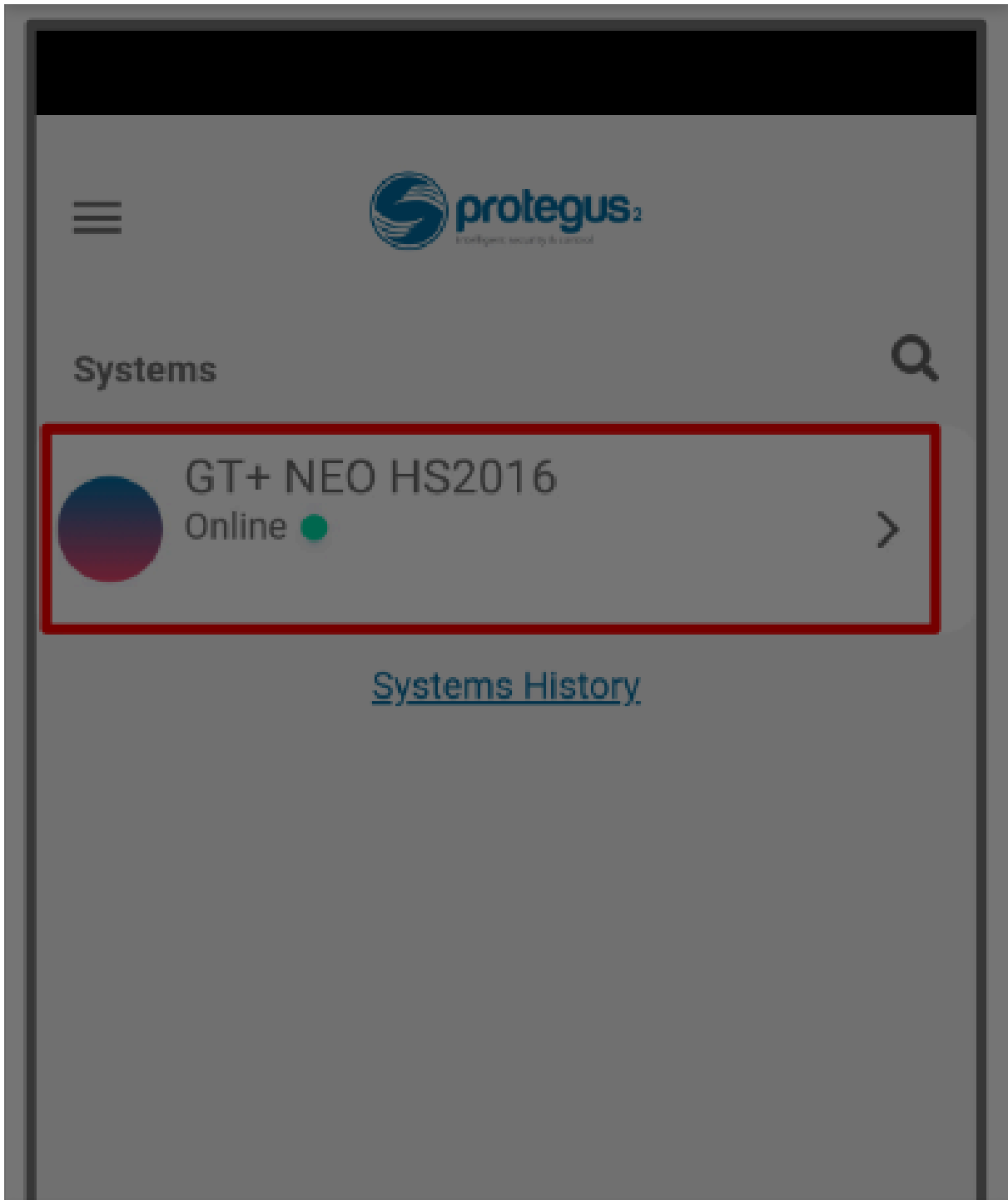

Cookie consent

We use cookies to measure the effectiveness of our documentation and whether users find what they're searching for. With your consent, you're helping us to make our documentation better.

Google Analytics





Paso 20. Espere 1 minuto para completar y pulse **Transferir**.

Cookie consent

We use cookies to measure the effectiveness of our documentation and whether users find what they're searching for. With your consent, you're helping us to make our documentation better.

Google Analytics



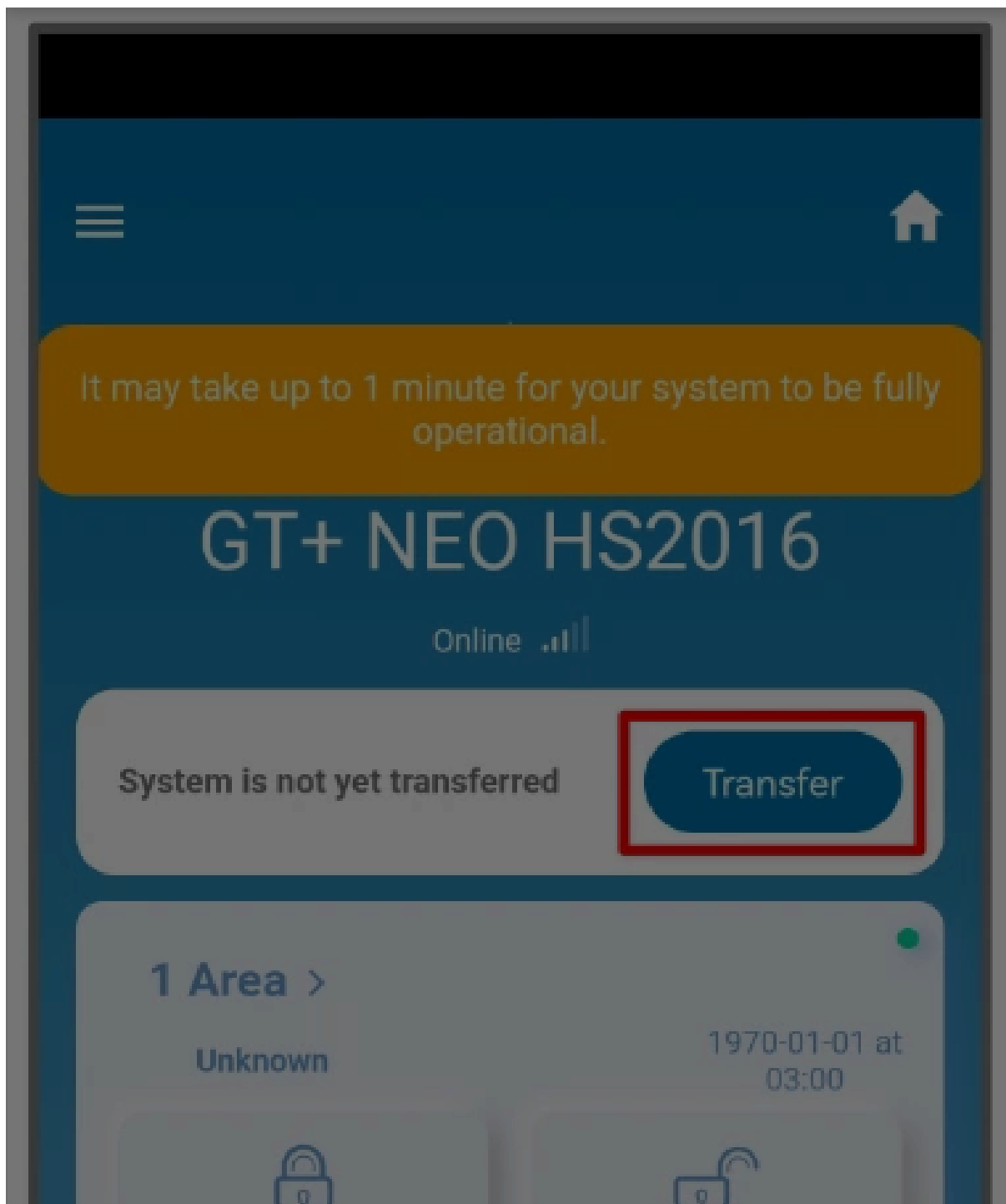

Cookie consent

We use cookies to measure the effectiveness of our documentation and whether users find what they're searching for. With your consent, you're helping us to make our documentation better.

Google Analytics





Paso 21. Introduzca el correo electrónico del usuario al que el instalador transferirá el sistema. Pulse **Transferir**.

Cookie consent

We use cookies to measure the effectiveness of our documentation and whether users find what they're searching for. With your consent, you're helping us to make our documentation better.

Google Analytics



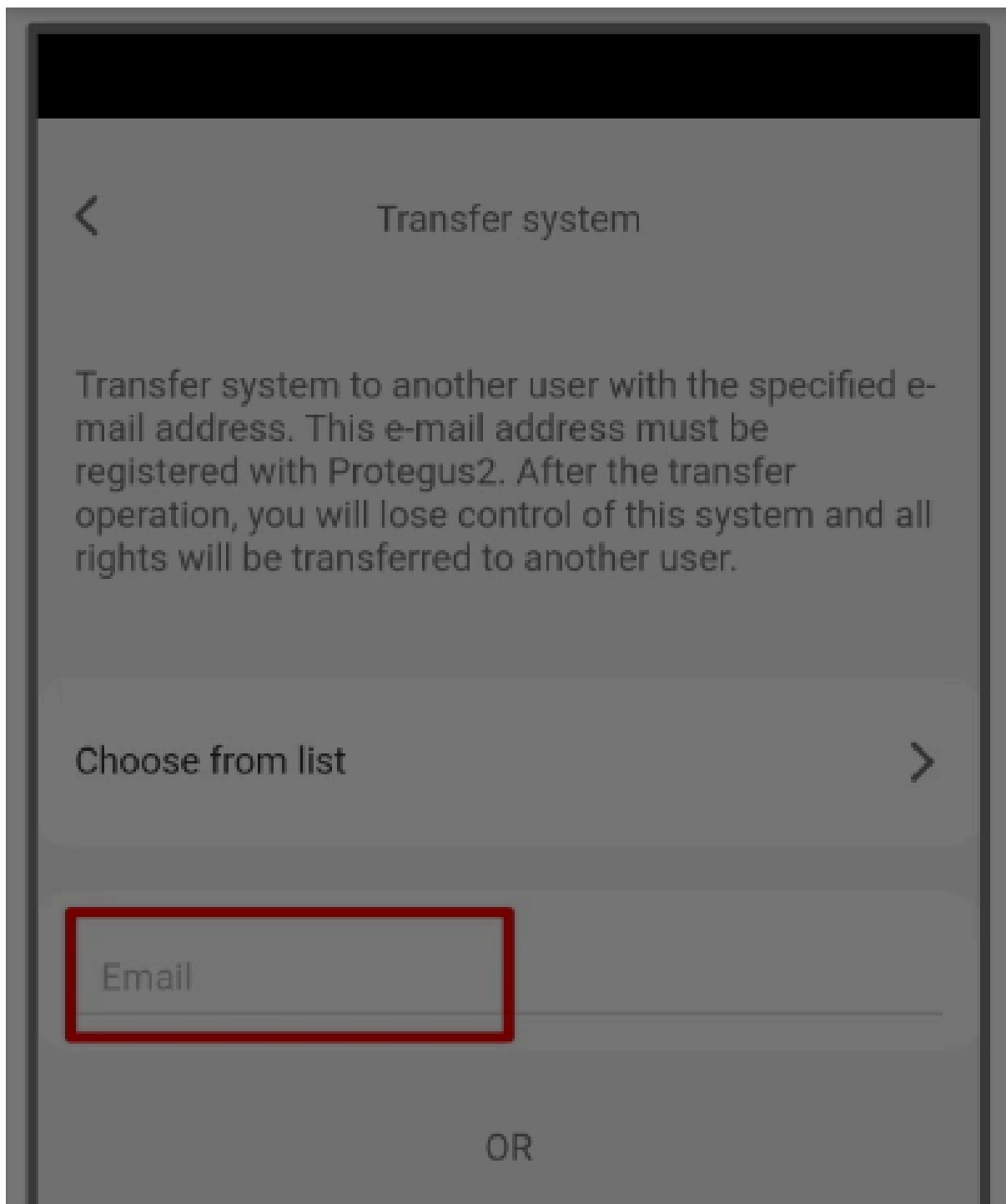

Cookie consent

We use cookies to measure the effectiveness of our documentation and whether users find what they're searching for. With your consent, you're helping us to make our documentation better.

Google Analytics





Transfer

Paso 22. El sistema aparecerá en Protegus en el teléfono del usuario.

Cookie consent

We use cookies to measure the effectiveness of our documentation and whether users find what they're searching for. With your consent, you're helping us to make our documentation better.

Google Analytics



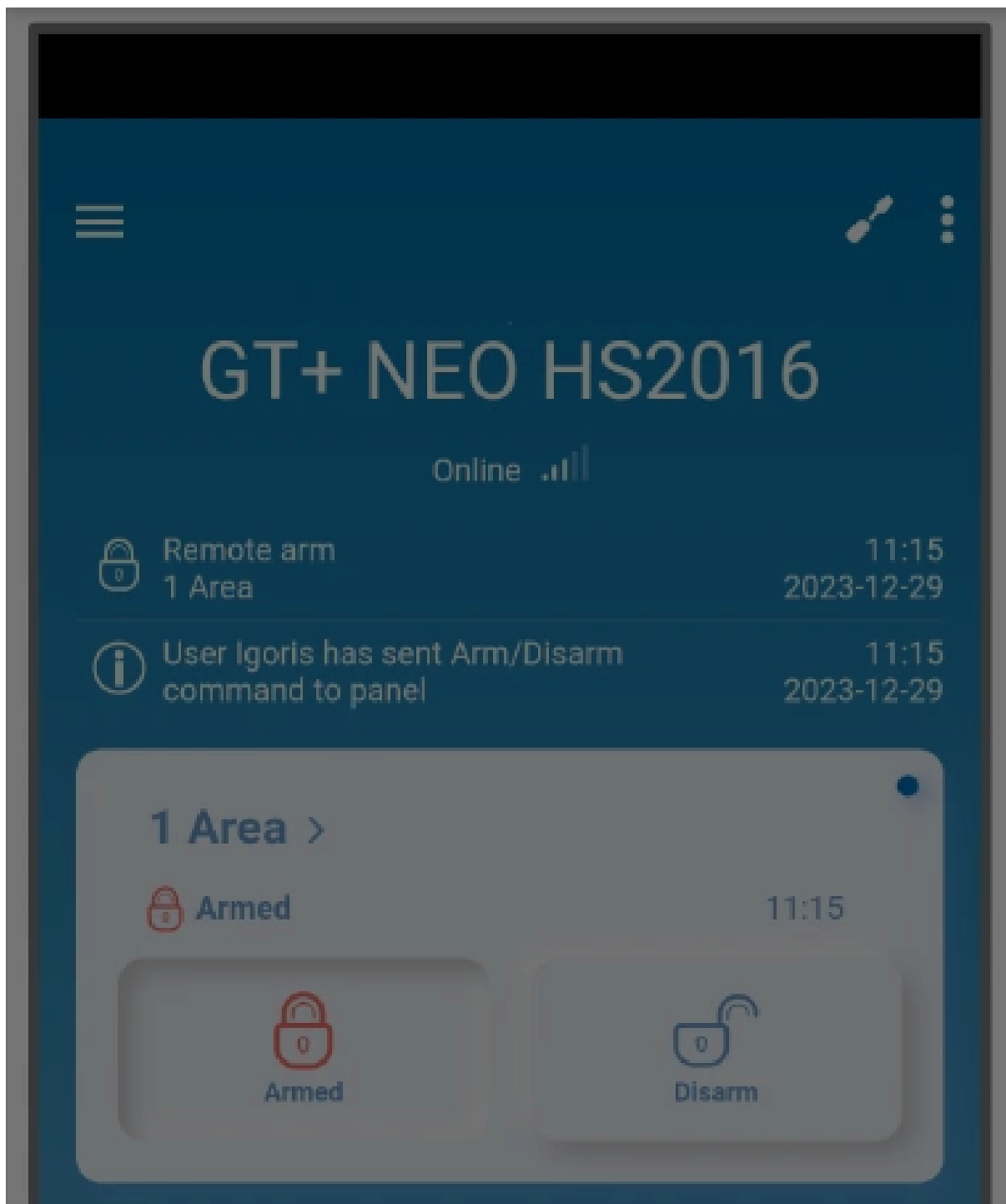

Cookie consent

We use cookies to measure the effectiveness of our documentation and whether users find what they're searching for. With your consent, you're helping us to make our documentation better.

Google Analytics





CONSEJO

Después de completar la configuración y la instalación realice una comprobación del sistema:

1. Cree un evento:

- armando/desarmando el sistema con el teclado del panel de control.
- provocando una alarma de zona cuando el sistema de seguridad está armado.

2. Asegúrese de que el evento llegue al CMS (Central Monitoring Station) y a la aplicación Protegus2.

Cookie consent

We use cookies to measure the effectiveness of our documentation and whether users find what they're searching for. With your consent, you're helping us to make our documentation better.

Google Analytics