

Texecom with GT/GT+/GET quick setup



GT product image

GT



GT+ product image

GT+



GET product image

GET

Short wiring and programming steps to connect the GT/GT+/GET communicator to Texecom Premier and Premier Elite panels using serial bus, then enroll the system in Protegus2. Use this alongside the full manuals for all other settings. (Terminal labels differ slightly between GT/GT+/GET, but the connections are the same.)



CAUTION

Install and service only by qualified personnel. Disconnect power before wiring. Unauthorized changes void warranty.

1. Prerequisites

1. GT/GT+/GET firmware 1.21, SIM inserted, PIN disabled, data plan active.
2. Texecom Premier / Premier Elite panel with installer access.
3. Texecom EX-CRP4 cable for serial connection.
4. CMS account number if reporting to CMS.
5. Protegus2 company/installer account and communicator IMEI.

2. Wiring

Cookie consent

We use cookies to measure the effectiveness of our documentation and whether users find what they're searching for. With your consent, you're helping us to make our documentation better.



Google Analytics

Accept

Reject

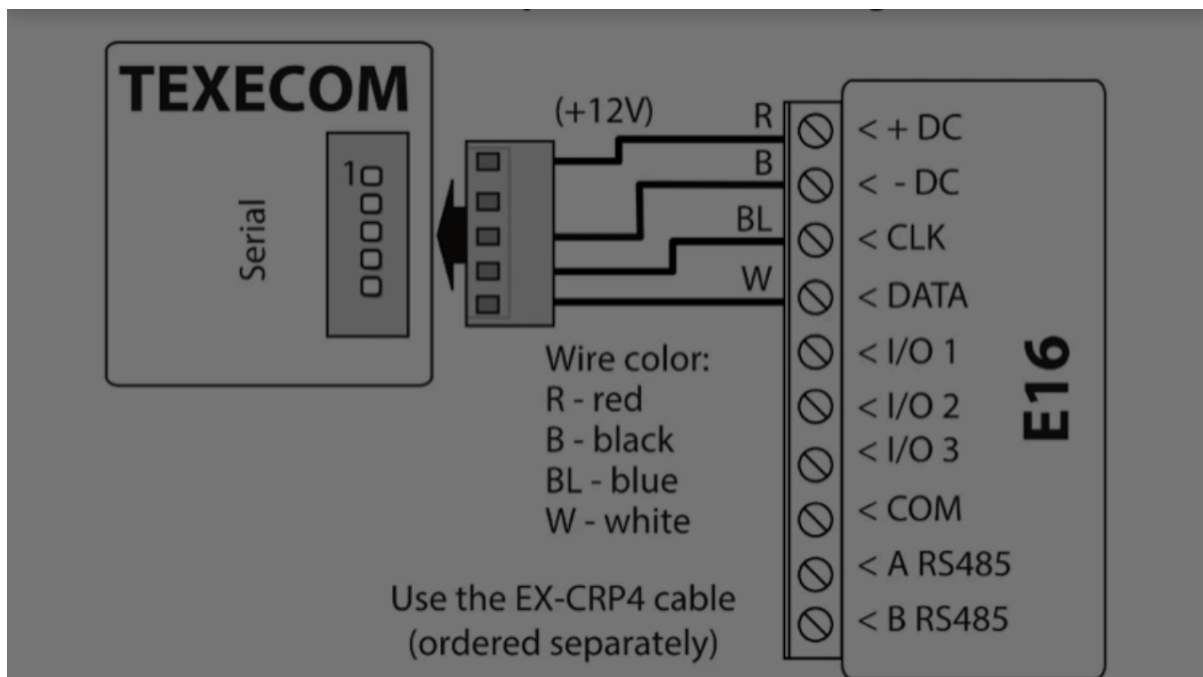

3. Programming the Texecom Alarm Panel

Texecom control panels must be programmed for both event reading and remote control.

1. In **Wintex**, open **Communication Options** and go to the **Options** tab.
2. Enter the 4-digit **UDL passcode**.
3. Make sure the **UDL passcode** matches the communicator **PC login password** used for remote control.
4. If programming from a keypad, enter the 4-digit installer code and press **[Menu]** to enter programming mode.
5. Press **[9]**, then **[7][6][2]**, and enter the 4-digit **UDL passcode**.
6. Press **[Yes]** and leave programming mode by pressing **[Menu]**.

4. Add systems to Protocols

Cookie consent

We use cookies to measure the effectiveness of our documentation and whether users find what they're searching for. With your consent, you're helping us to make our documentation better.

Google Analytics



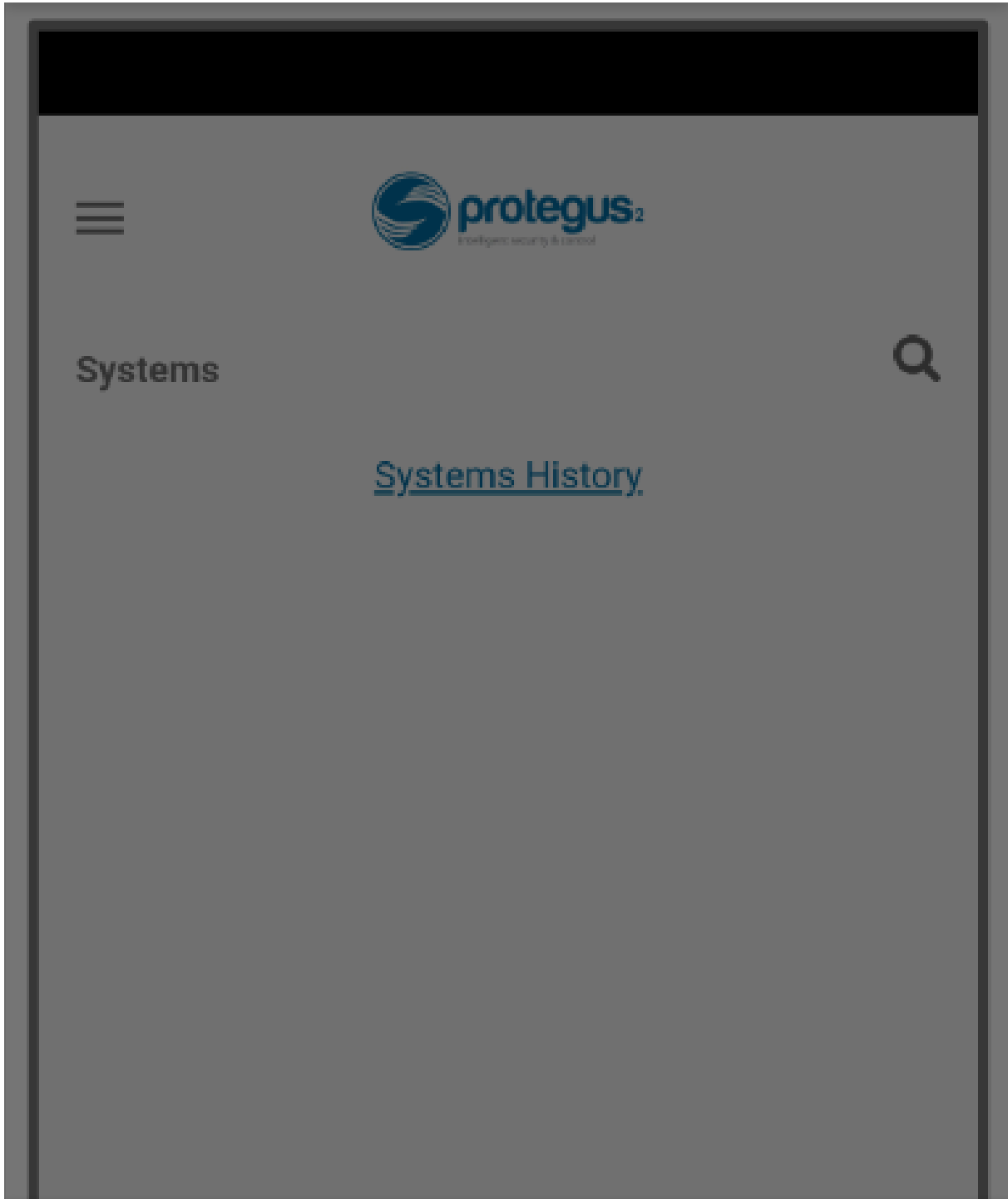

Cookie consent

We use cookies to measure the effectiveness of our documentation and whether users find what they're searching for. With your consent, you're helping us to make our documentation better.

- Google Analytics





Step 2. Enter the communicator **IMEI**, tap **Next**.

Cookie consent

We use cookies to measure the effectiveness of our documentation and whether users find what they're searching for. With your consent, you're helping us to make our documentation better.

Google Analytics



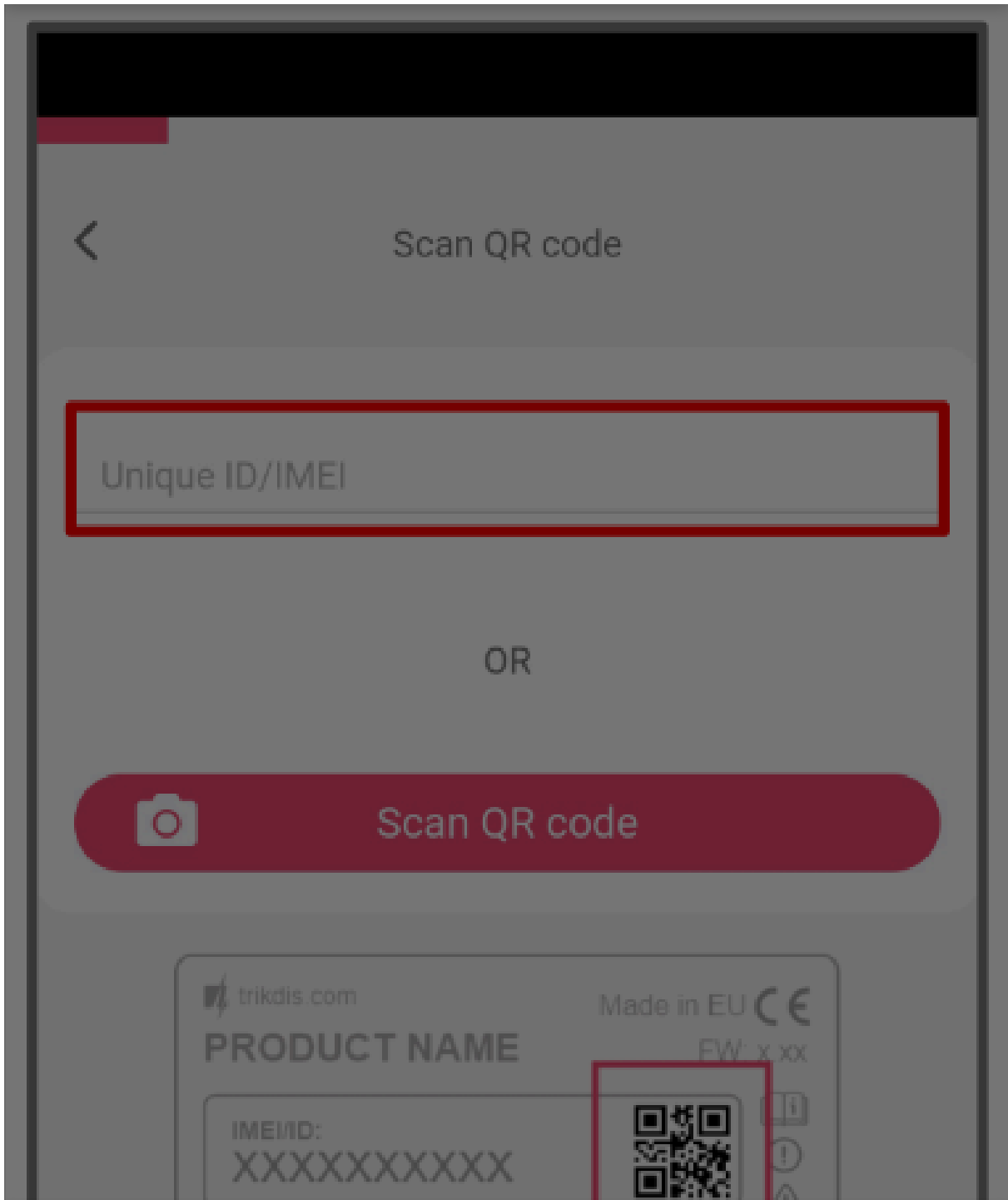

Cookie consent

We use cookies to measure the effectiveness of our documentation and whether users find what they're searching for. With your consent, you're helping us to make our documentation better.

Google Analytics

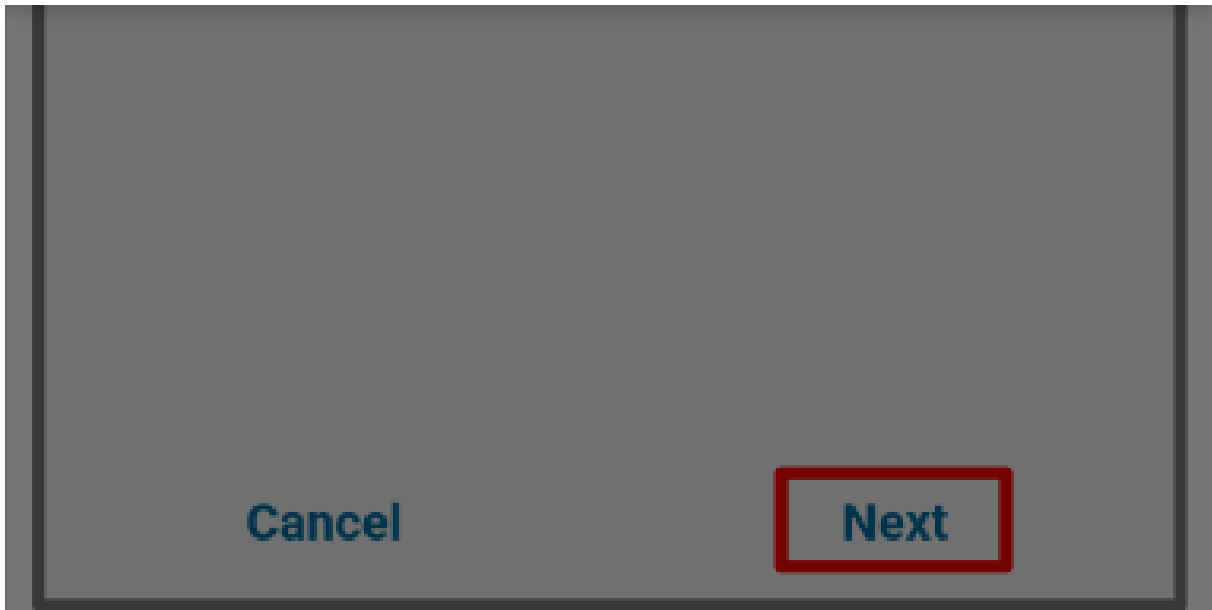

Step 3. Select security company.

Cookie consent

We use cookies to measure the effectiveness of our documentation and whether users find what they're searching for. With your consent, you're helping us to make our documentation better.

Google Analytics

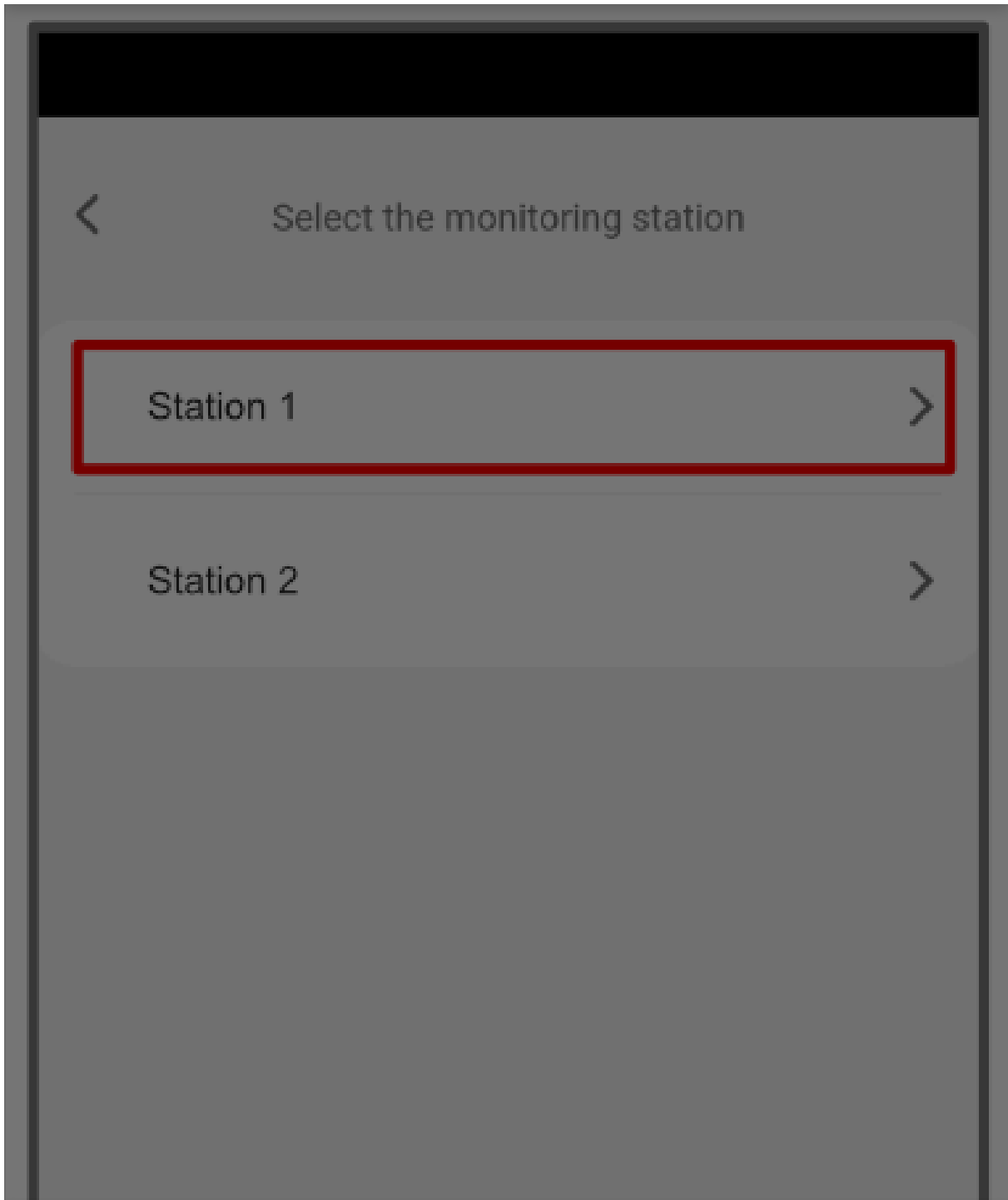

Cookie consent

We use cookies to measure the effectiveness of our documentation and whether users find what they're searching for. With your consent, you're helping us to make our documentation better.

Google Analytics



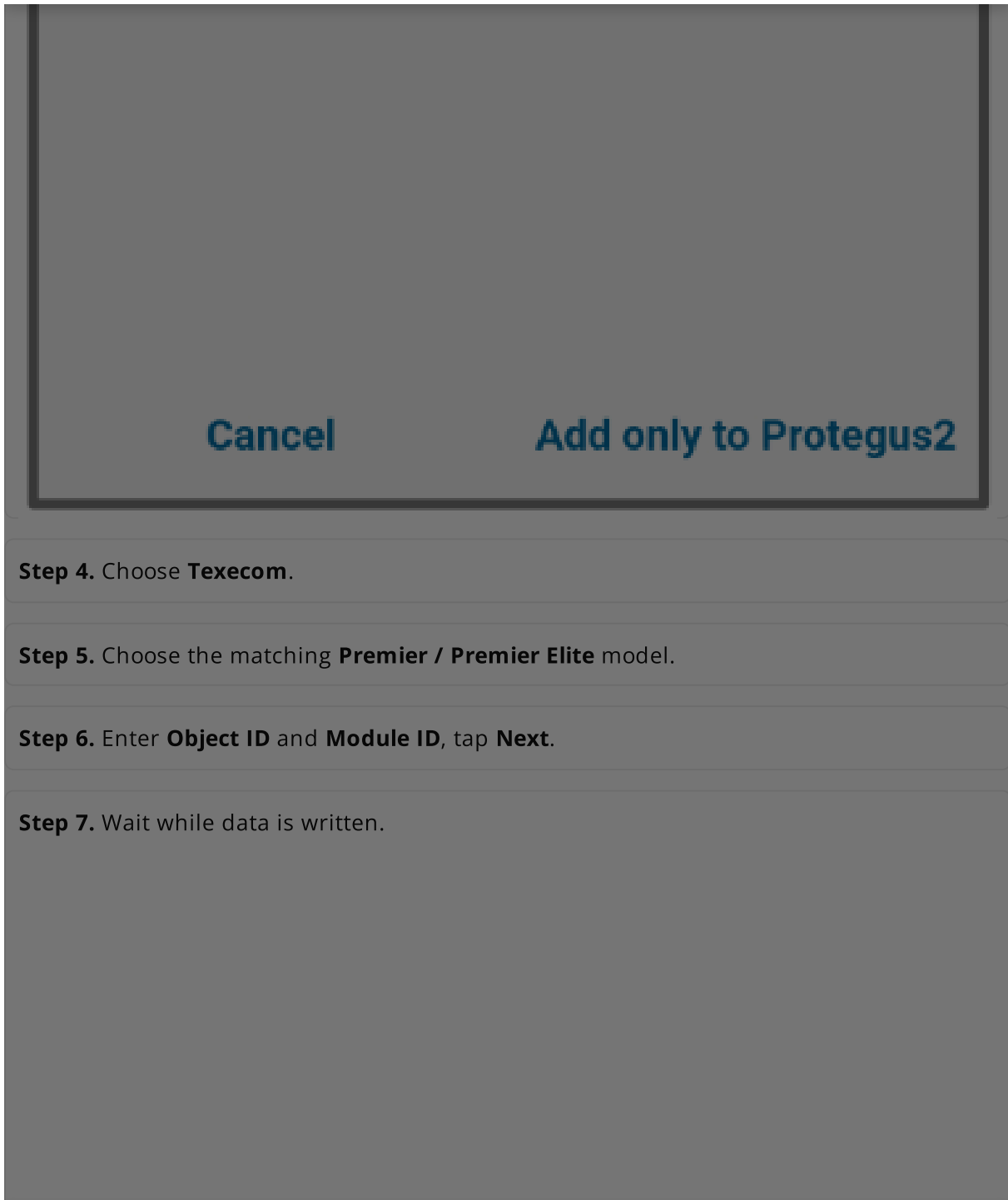

Cookie consent

We use cookies to measure the effectiveness of our documentation and whether users find what they're searching for. With your consent, you're helping us to make our documentation better.

Google Analytics



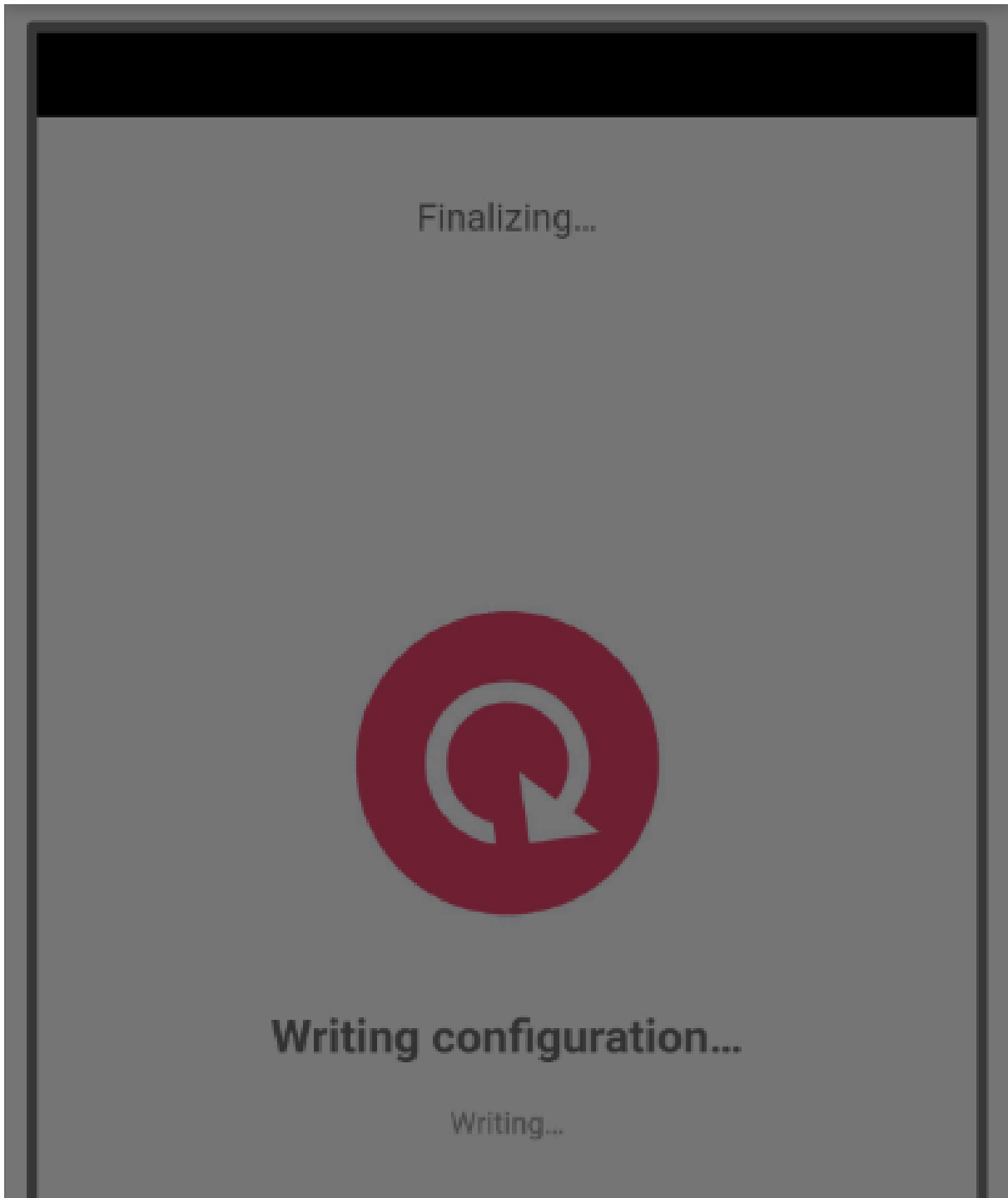

Cookie consent

We use cookies to measure the effectiveness of our documentation and whether users find what they're searching for. With your consent, you're helping us to make our documentation better.

Google Analytics





Cancel

Step 8. Tap Add to Protegus2.

Cookie consent

We use cookies to measure the effectiveness of our documentation and whether users find what they're searching for. With your consent, you're helping us to make our documentation better.

Google Analytics



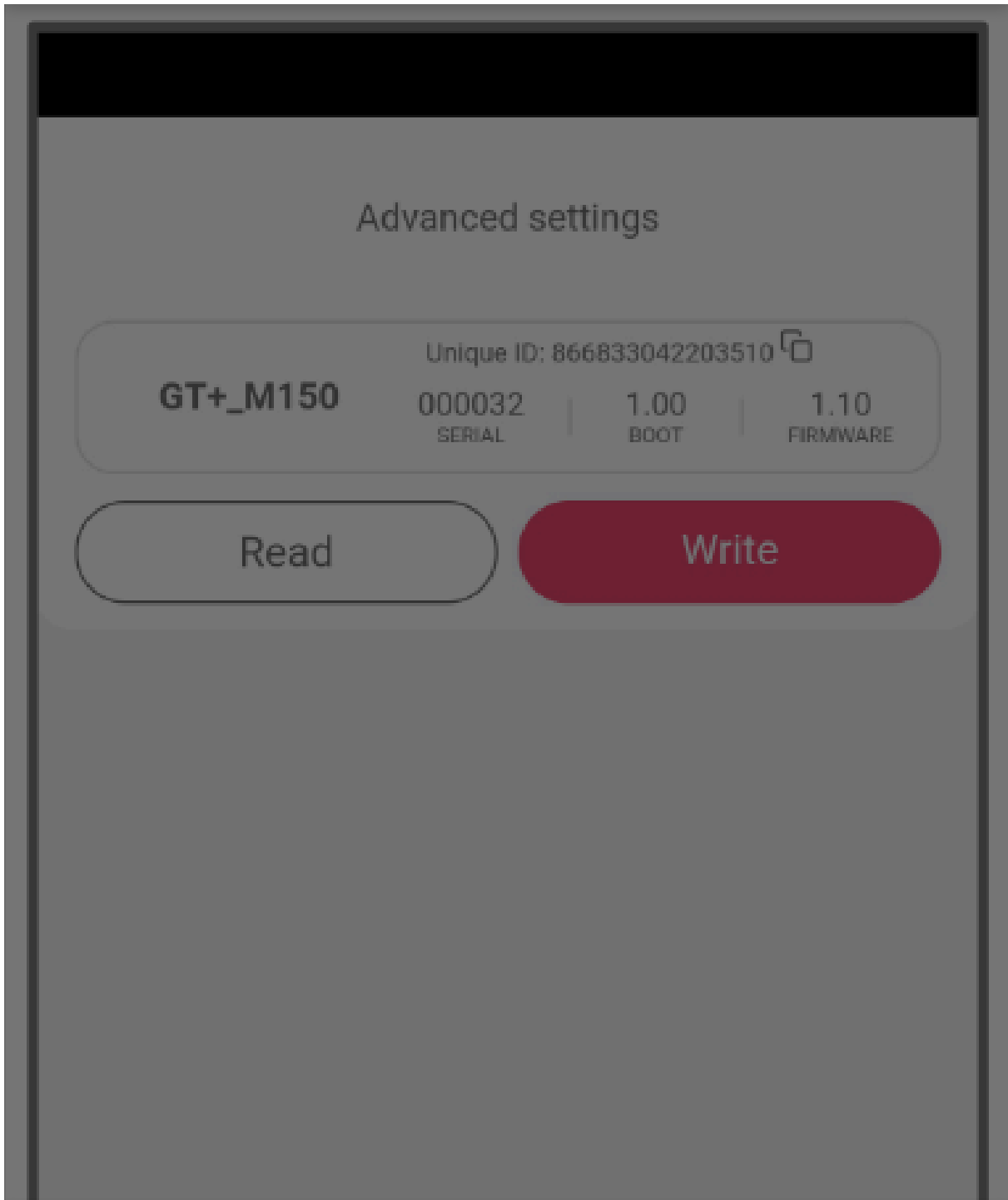

Cookie consent

We use cookies to measure the effectiveness of our documentation and whether users find what they're searching for. With your consent, you're helping us to make our documentation better.

Google Analytics

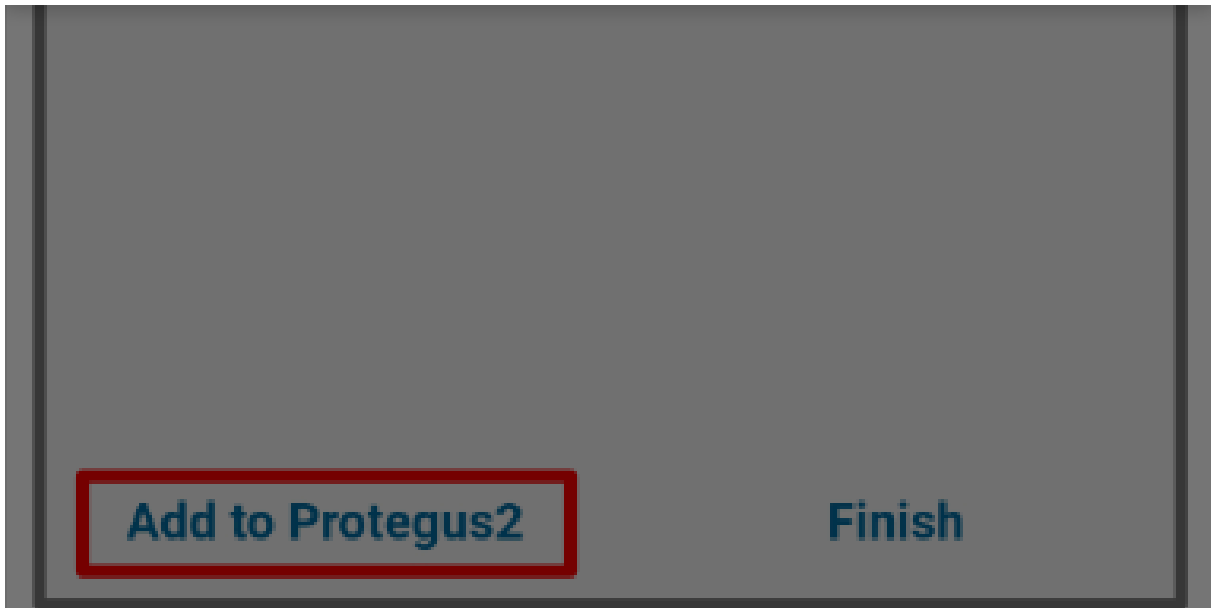

Step 9. Enter system **Name**, tap **Next**.

Cookie consent

We use cookies to measure the effectiveness of our documentation and whether users find what they're searching for. With your consent, you're helping us to make our documentation better.

Google Analytics





Cookie consent

We use cookies to measure the effectiveness of our documentation and whether users find what they're searching for. With your consent, you're helping us to make our documentation better.

Google Analytics



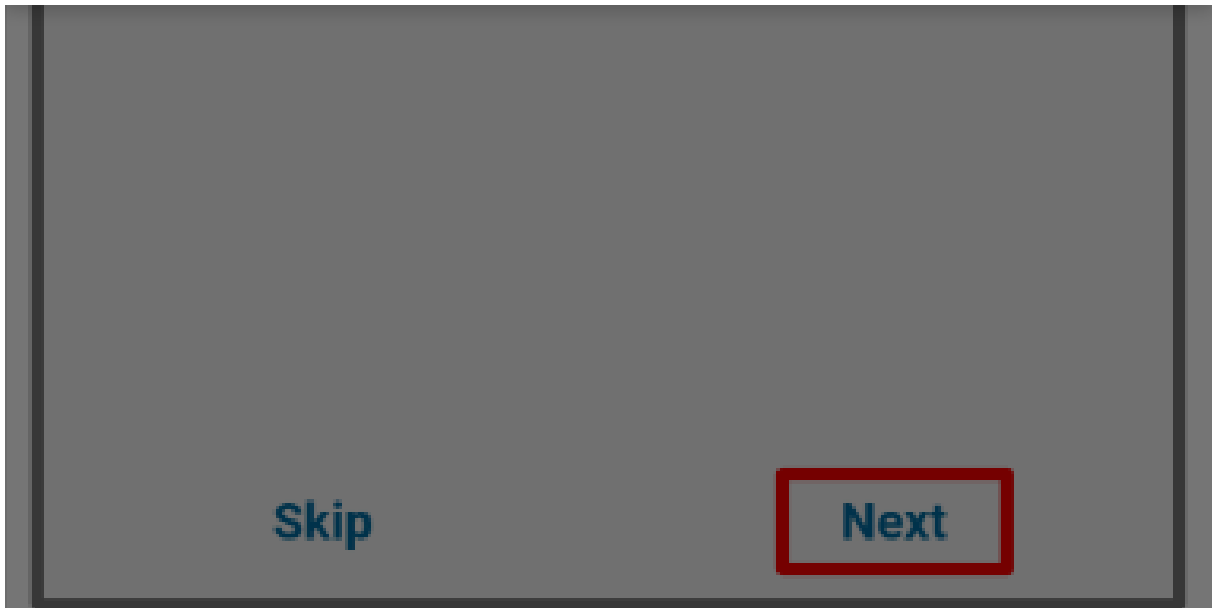

Step 10. Tap **Skip**.

Cookie consent

We use cookies to measure the effectiveness of our documentation and whether users find what they're searching for. With your consent, you're helping us to make our documentation better.

Google Analytics



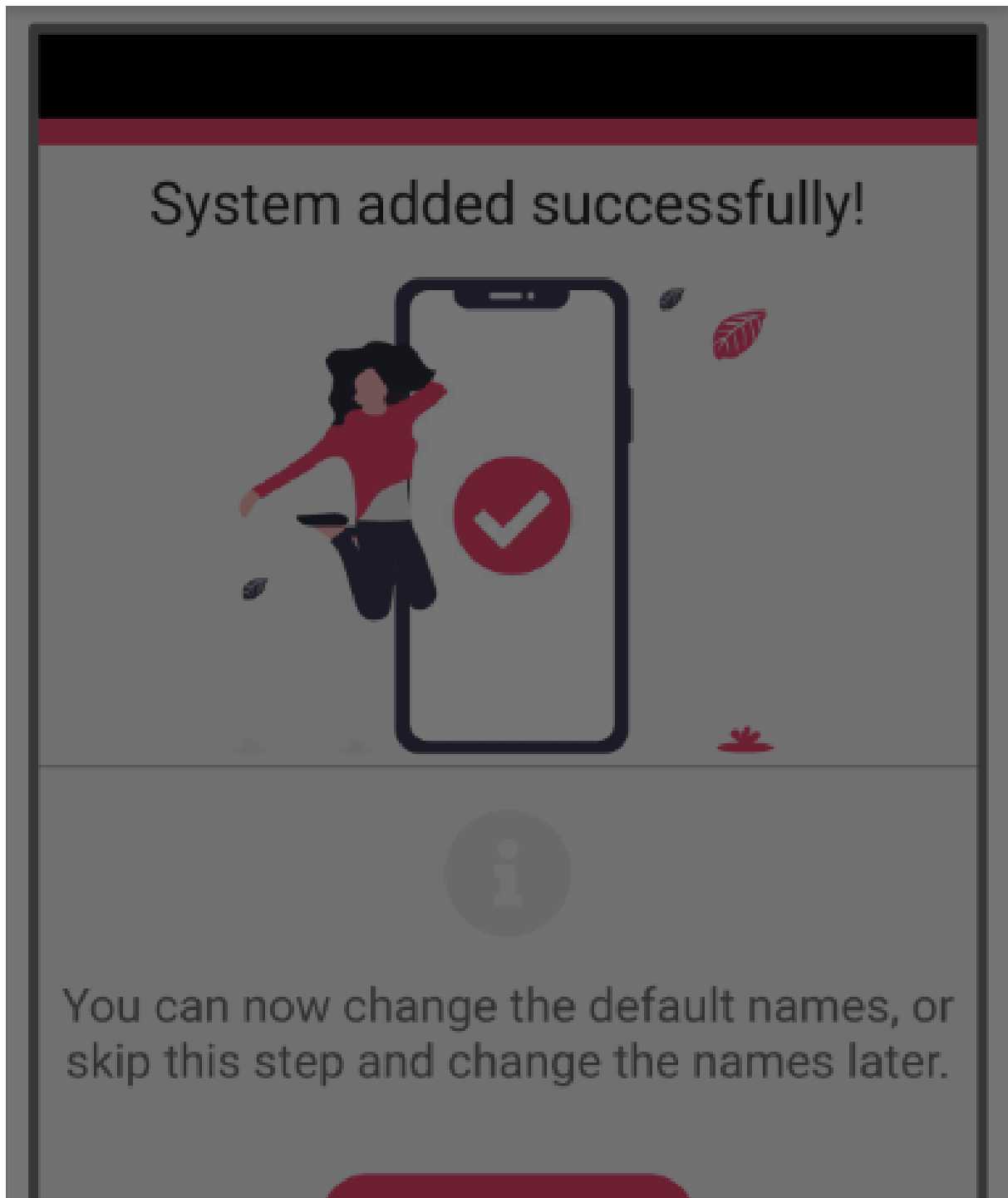

Cookie consent

We use cookies to measure the effectiveness of our documentation and whether users find what they're searching for. With your consent, you're helping us to make our documentation better.

Google Analytics

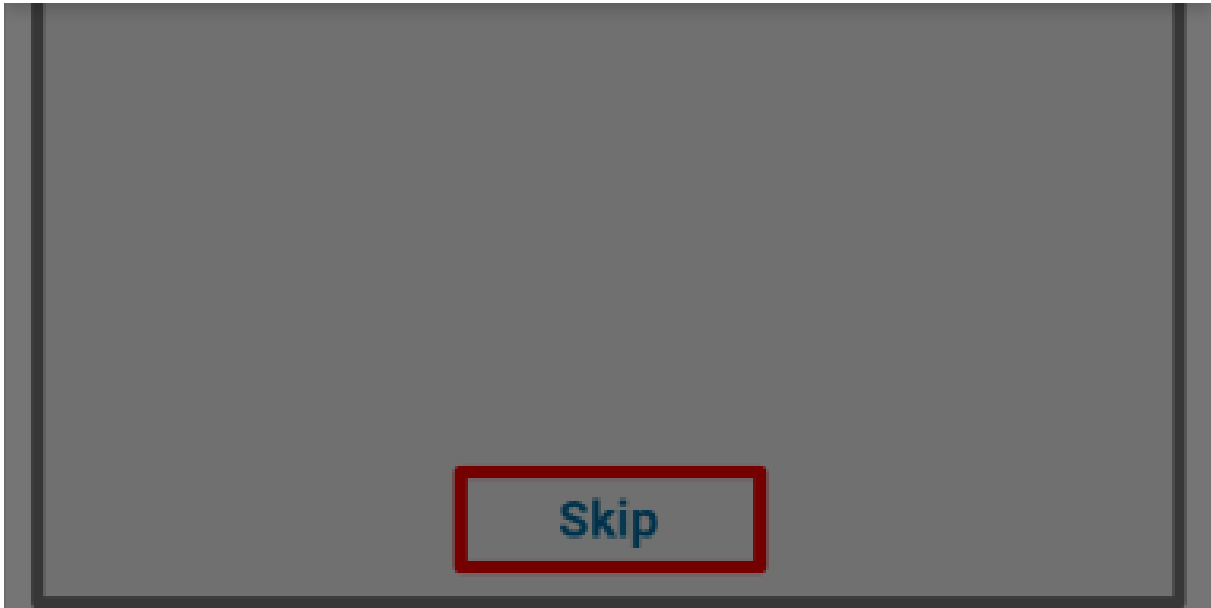

Step 11. Tap on system.

Cookie consent

We use cookies to measure the effectiveness of our documentation and whether users find what they're searching for. With your consent, you're helping us to make our documentation better.

Google Analytics





Cookie consent

We use cookies to measure the effectiveness of our documentation and whether users find what they're searching for. With your consent, you're helping us to make our documentation better.

Google Analytics





Step 12. Wait 1 minute for completion and tap **Transfer**.

Cookie consent

We use cookies to measure the effectiveness of our documentation and whether users find what they're searching for. With your consent, you're helping us to make our documentation better.

Google Analytics



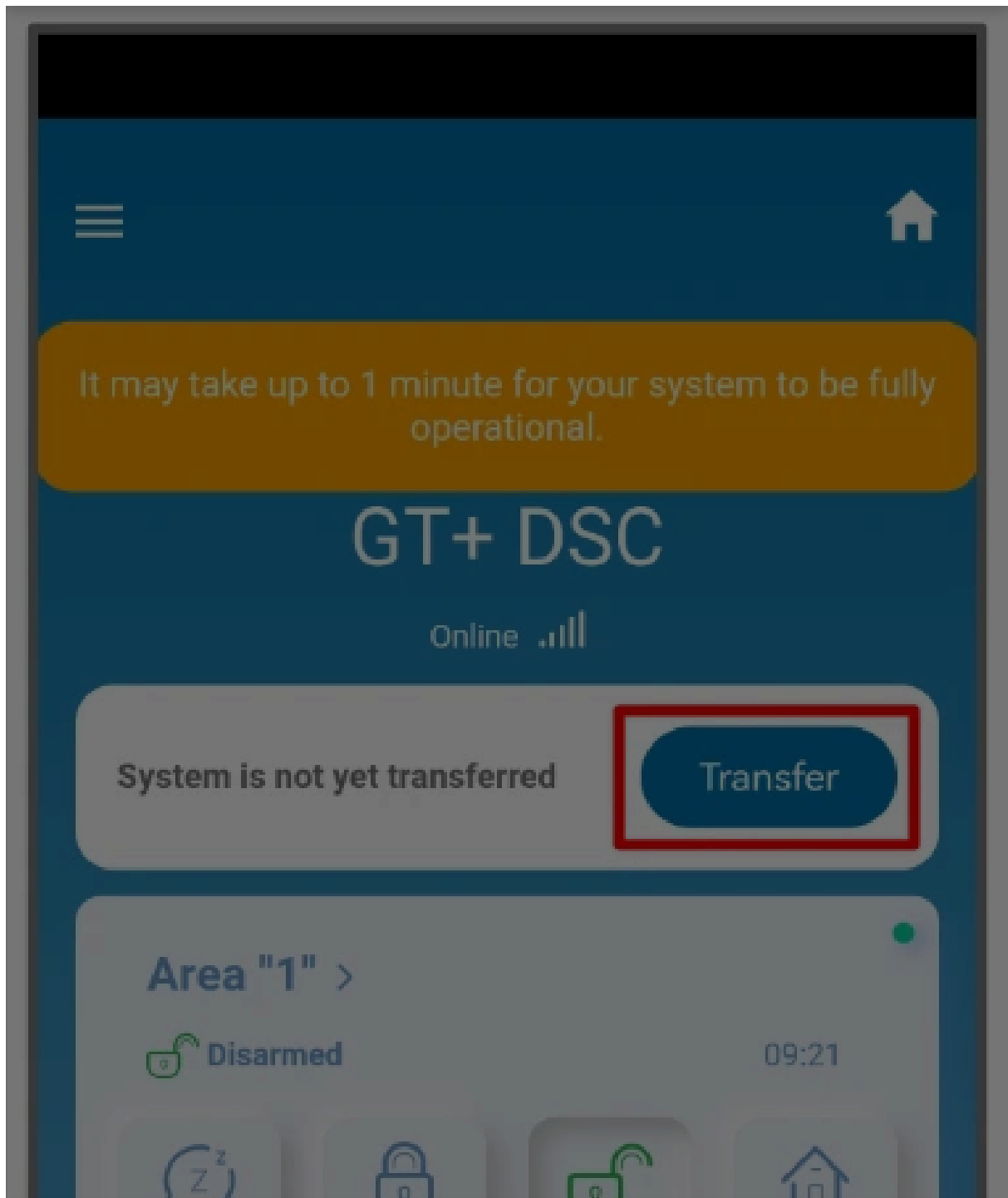

Cookie consent

We use cookies to measure the effectiveness of our documentation and whether users find what they're searching for. With your consent, you're helping us to make our documentation better.

Google Analytics



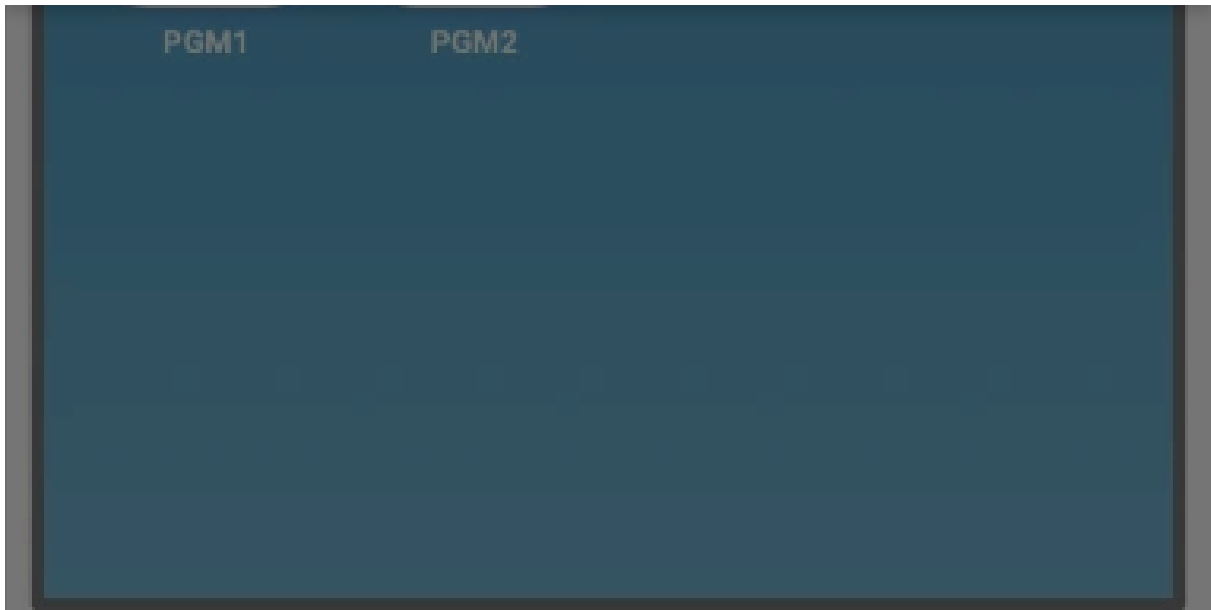

Step 13. Enter the e-mail of the user to whom the installer will transfer the system. Tap **Transfer**.

Cookie consent

We use cookies to measure the effectiveness of our documentation and whether users find what they're searching for. With your consent, you're helping us to make our documentation better.

Google Analytics



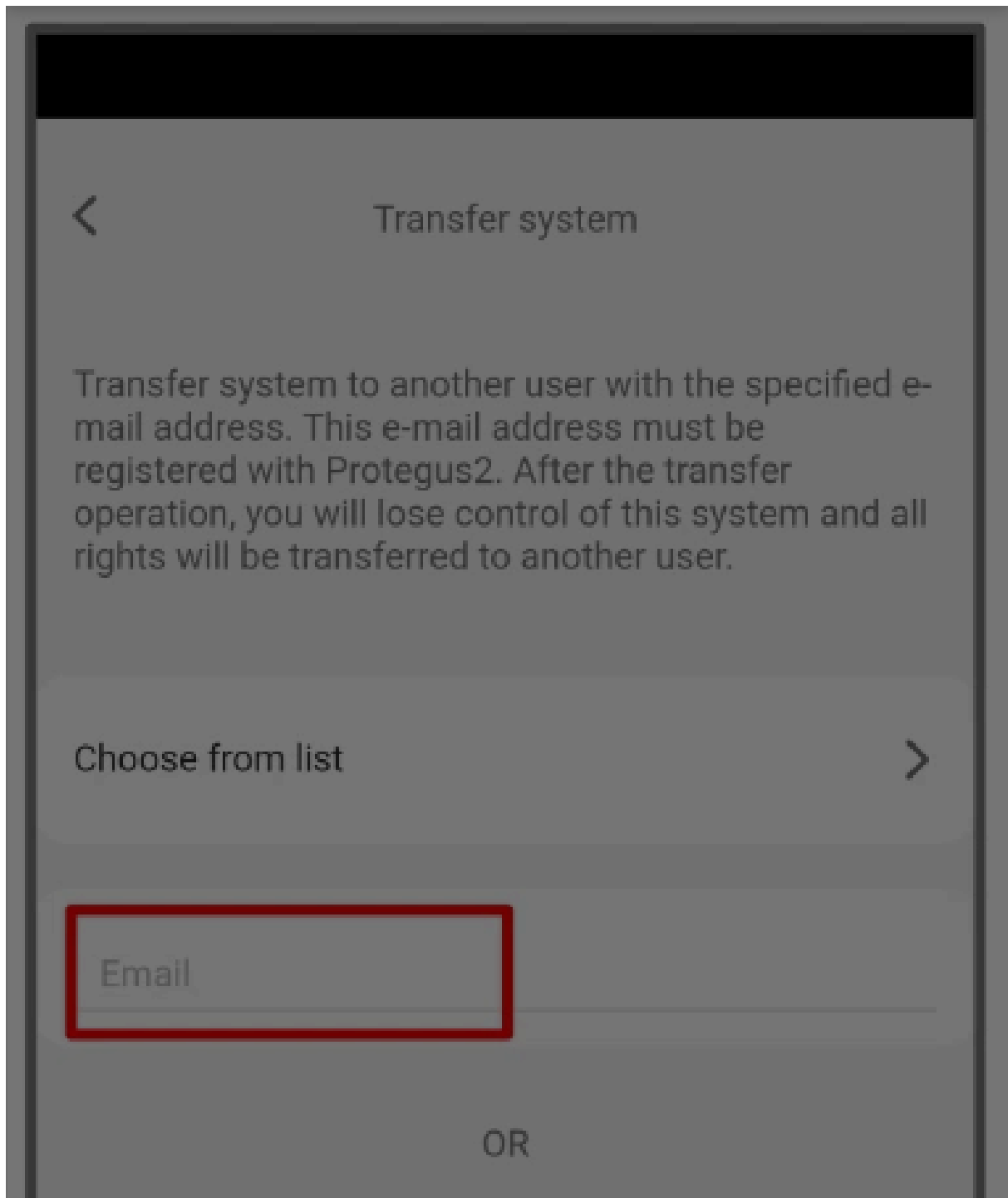

Cookie consent

We use cookies to measure the effectiveness of our documentation and whether users find what they're searching for. With your consent, you're helping us to make our documentation better.

Google Analytics



Transfer

Step 14. The system will appear in Protegus on the user's phone.

Cookie consent

We use cookies to measure the effectiveness of our documentation and whether users find what they're searching for. With your consent, you're helping us to make our documentation better.

Google Analytics

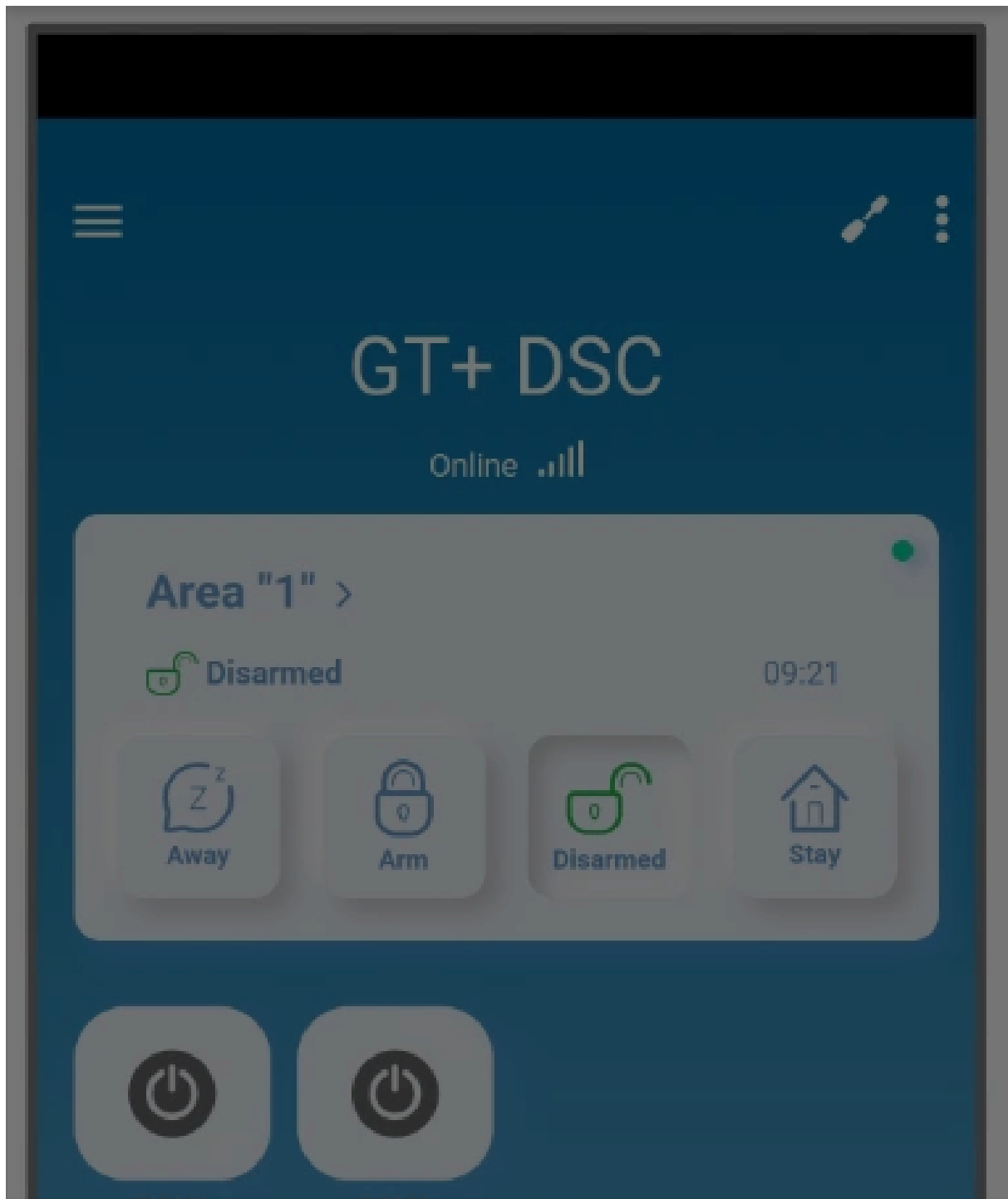

Cookie consent

We use cookies to measure the effectiveness of our documentation and whether users find what they're searching for. With your consent, you're helping us to make our documentation better.

Google Analytics





5. System check

TIP

After completing the setup and installation perform a system check:

1. Create an event:

- by arming/disarming the system with the control panel's keypad.
- by triggering a zone alarm when the security system is armed.

2. Make sure that the event arrives to the CMS (Central Monitoring Station) and the Protegus2 app.

Cookie consent

We use cookies to measure the effectiveness of our documentation and whether users find what they're searching for. With your consent, you're helping us to make our documentation better.

Google Analytics