

КОММУНИКАТОРЫ

# DSC NEO HS2016 с GT/GT+/GET быстрая настройка



GT product image

GT



GT+ product image

GT+



GET product image

GET

Краткие шаги по подключению и программированию для подключения коммуникатора GT/GT+/GET к панели DSC NEO HS2016 через терминалы TIP/RING, затем добавления системы в Protegus2. Используйте вместе с полными руководствами для остальных настроек. (Обозначения клемм на GT/GT+/GET могут немного отличаться, но подключения одинаковые.)



## ОСТОРОЖНО

Установку и обслуживание должны выполнять только квалифицированные специалисты. Перед подключением отключите питание. Несанкционированные изменения аннулируют гарантию.

## 1. Требования

1. Прошивка GT/GT+/GET 1.21, SIM-карта установлена, PIN отключен, активен тариф с передачей данных.
2. Панель DSC NEO HS2016 с доступом к клавиатуре (есть код установщика).
3. Номер учетной записи CMS, если используется передача в CMS.
4. Учетная запись компании/установщика Protegus2 и IMEI коммуникатора.

### Cookie consent

We use cookies to measure the effectiveness of our documentation and whether users find what they're searching for. With your consent, you're helping us to make our documentation better.



Google Analytics

Accept

Reject

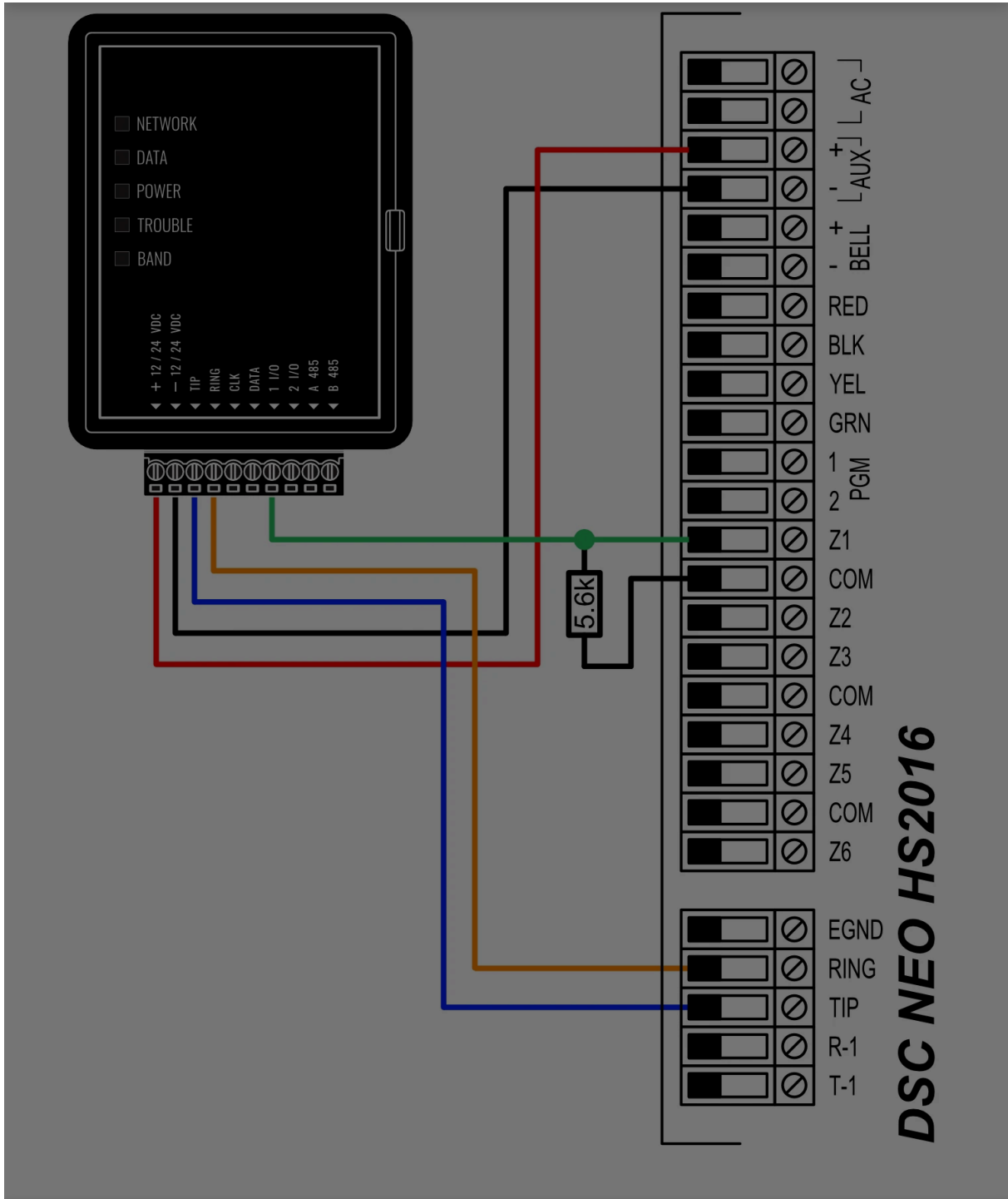

**DSC NEO HS2016**

**Cookie consent**

We use cookies to measure the effectiveness of our documentation and whether users find what they're searching for. With your consent, you're helping us to make our documentation better.

- Google Analytics





Ввод с клавиатуры	Описание действия
*85555	Войти в режим программирования
001*	Вход в программирование "Zone type"
066##	Установить тип зоны "Momentary keyswitch"
301*	Вход в программирование "Phone Number"
<1234##	Ввести телефонный номер (1234)
310*	Вход в программирование "Account Codes"
1111	Ввести "System Account Code" (1111)
001	
2222#	Ввести "Partition 1 Account Code" (2222)
311	Вход в программирование "Partition 1 Call Direction"
003*##	Включить "Partition Opening/Closing Call Direction" (Y)
350*	Вход в программирование "Communicator Formats"
03#	03 – формат Contact ID.
##	Выйти из режима программирования.

## 4. Добавление системы в Protegus2

**Шаг 1.** Нажмите **Add new system**.

### Cookie consent

We use cookies to measure the effectiveness of our documentation and whether users find what they're searching for. With your consent, you're helping us to make our documentation better.

Google Analytics

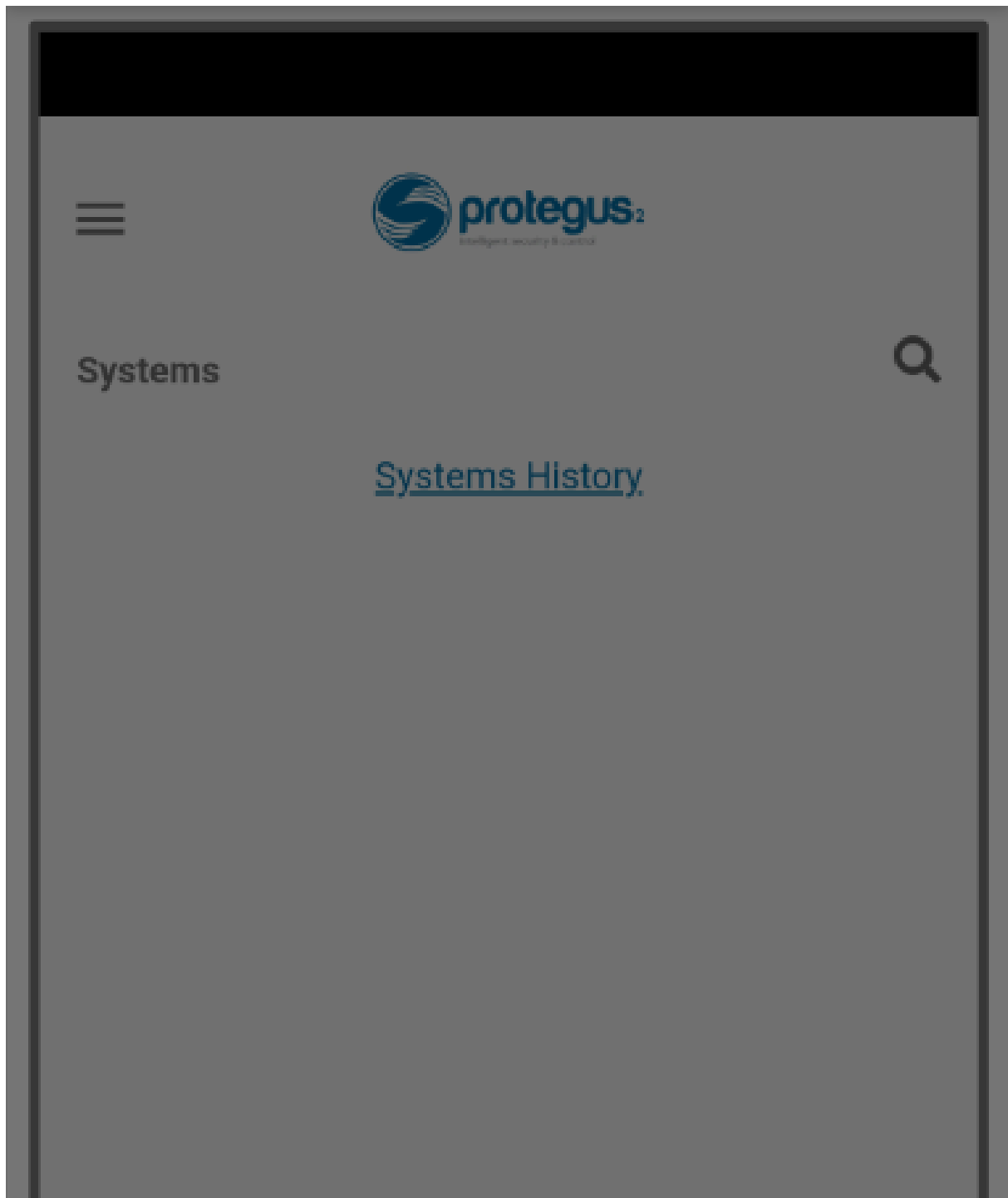

### Cookie consent

We use cookies to measure the effectiveness of our documentation and whether users find what they're searching for. With your consent, you're helping us to make our documentation better.

Google Analytics





**Шаг 2.** Введите **IMEI** коммуникатора, нажмите **Next**.

### Cookie consent

We use cookies to measure the effectiveness of our documentation and whether users find what they're searching for. With your consent, you're helping us to make our documentation better.

Google Analytics



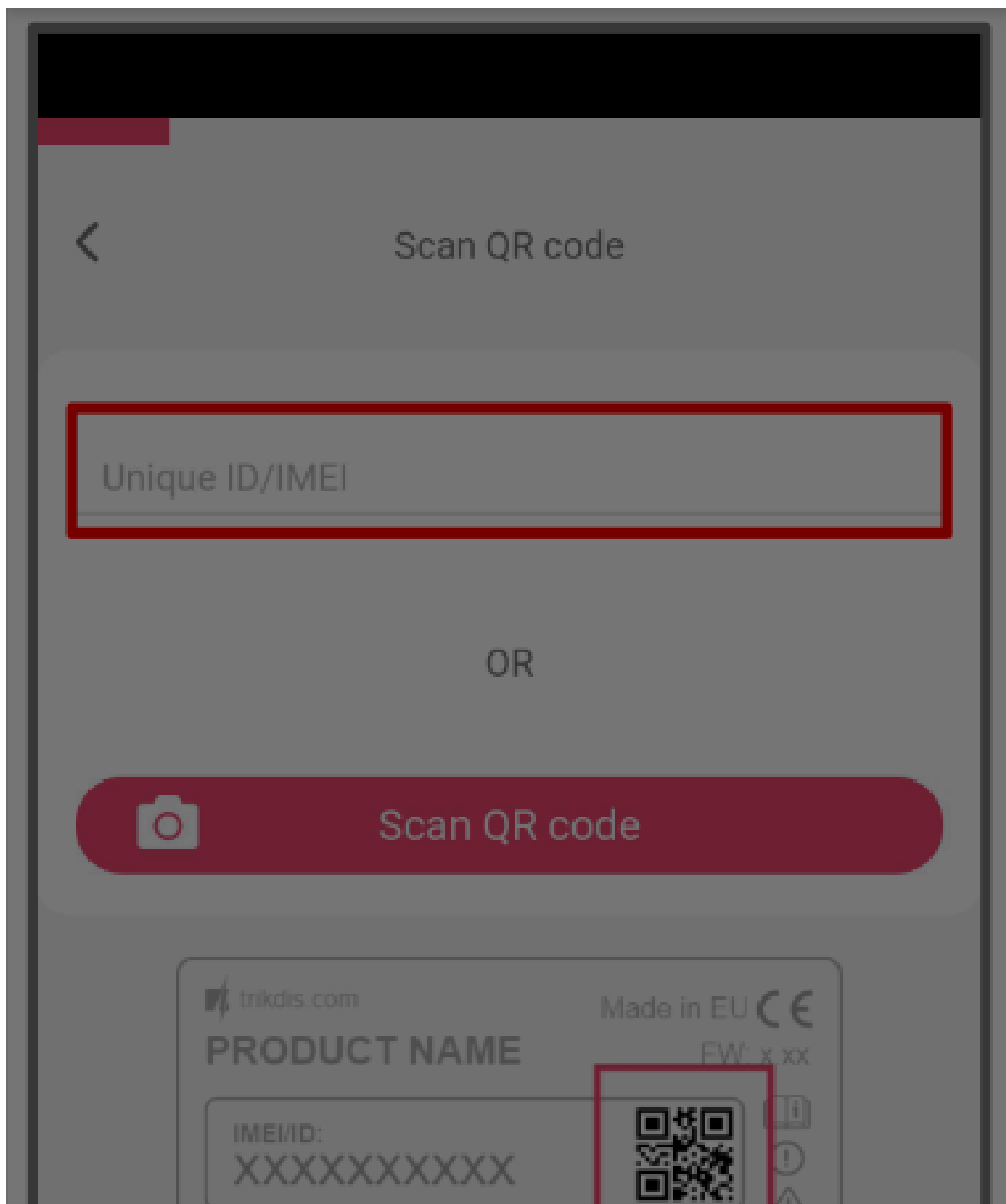

### Cookie consent

We use cookies to measure the effectiveness of our documentation and whether users find what they're searching for. With your consent, you're helping us to make our documentation better.

Google Analytics



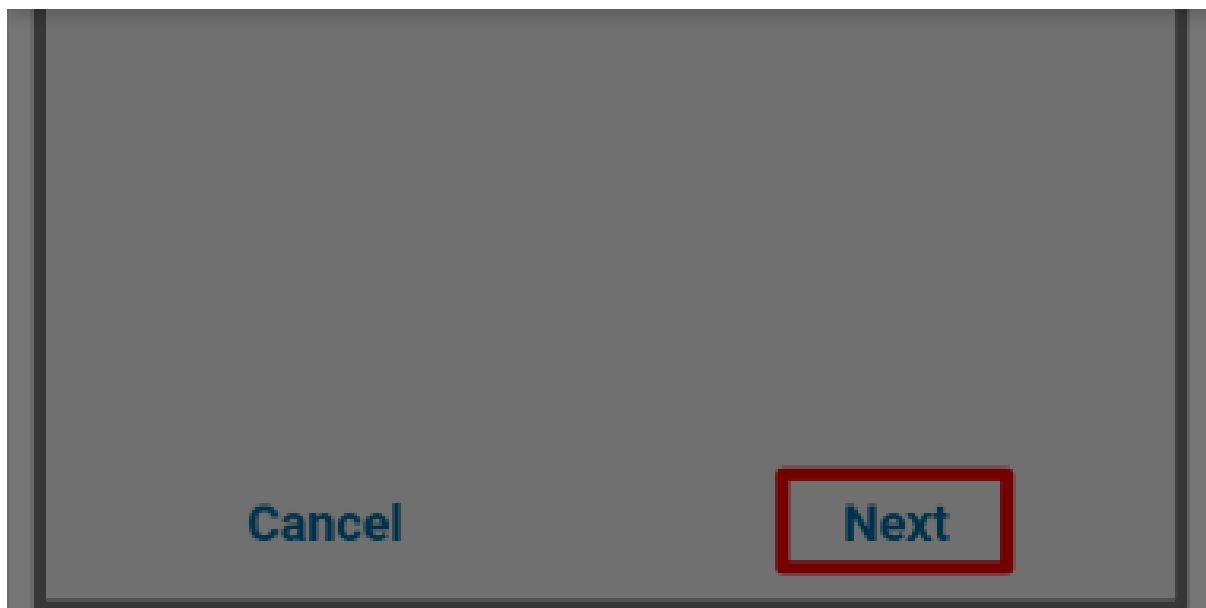

**Шаг 3.** Выберите охранную компанию.

### Cookie consent

We use cookies to measure the effectiveness of our documentation and whether users find what they're searching for. With your consent, you're helping us to make our documentation better.

Google Analytics



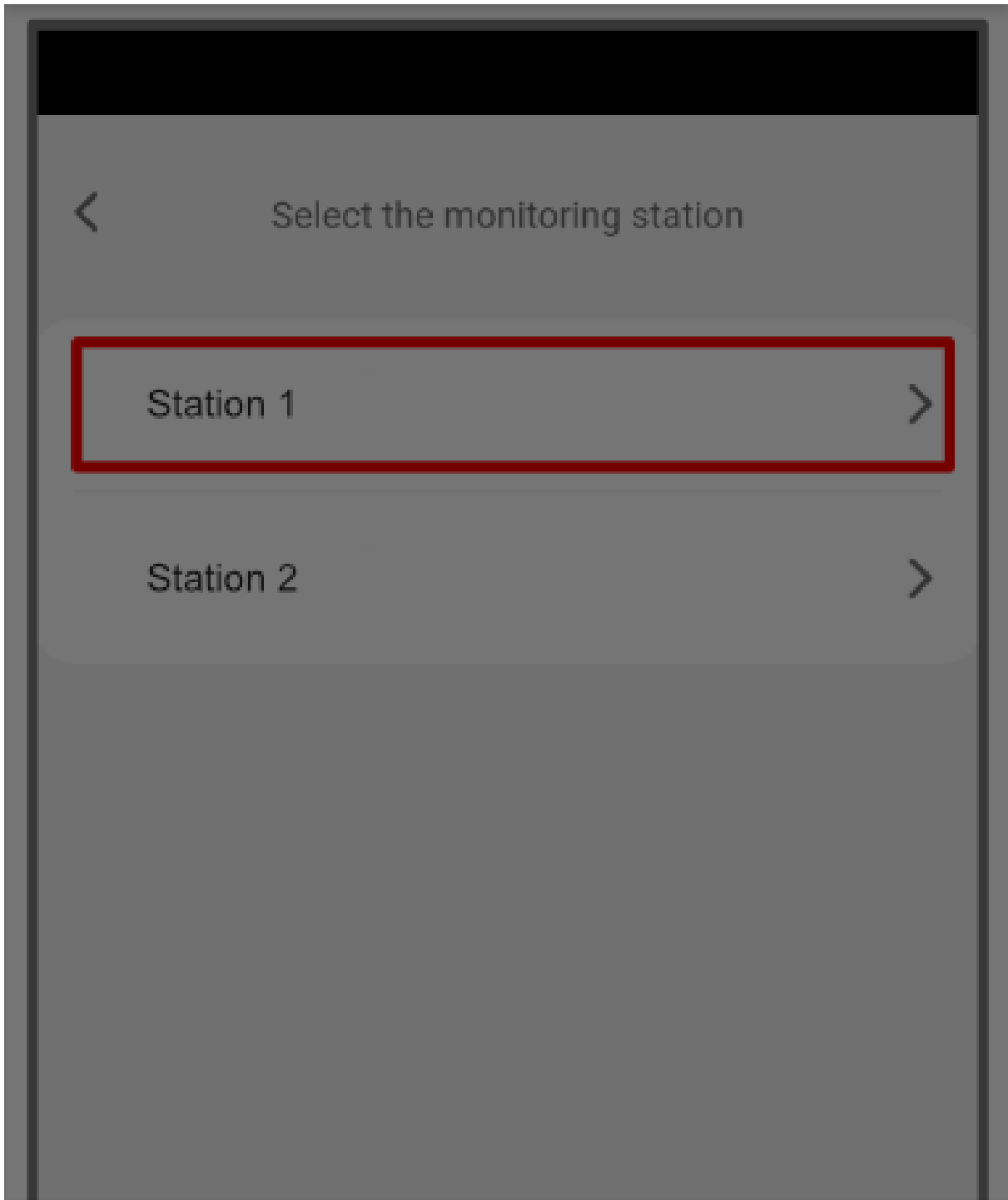

### Cookie consent

We use cookies to measure the effectiveness of our documentation and whether users find what they're searching for. With your consent, you're helping us to make our documentation better.

Google Analytics





Cancel

Add only to Protegus2

**Шаг 4.** Выберите **TIP RING**.

### Cookie consent

We use cookies to measure the effectiveness of our documentation and whether users find what they're searching for. With your consent, you're helping us to make our documentation better.

Google Analytics



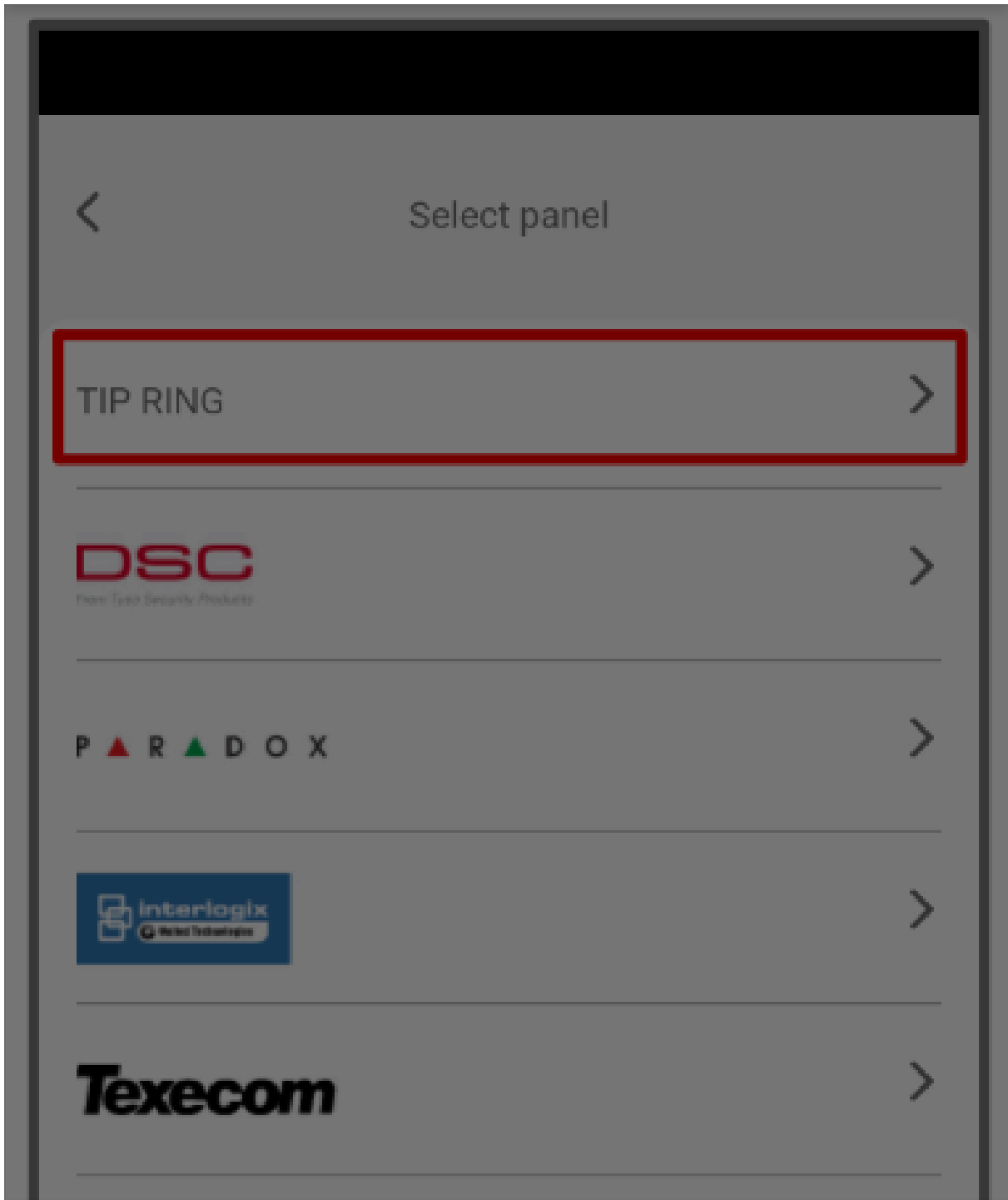

### Cookie consent

We use cookies to measure the effectiveness of our documentation and whether users find what they're searching for. With your consent, you're helping us to make our documentation better.

Google Analytics





Cancel

**Шаг 5.** Выберите **Mode**.

### Cookie consent

We use cookies to measure the effectiveness of our documentation and whether users find what they're searching for. With your consent, you're helping us to make our documentation better.

Google Analytics





### Cookie consent

We use cookies to measure the effectiveness of our documentation and whether users find what they're searching for. With your consent, you're helping us to make our documentation better.

Google Analytics





Cancel

Next

**Шаг 6.** Выберите **AUTO**.

### Cookie consent

We use cookies to measure the effectiveness of our documentation and whether users find what they're searching for. With your consent, you're helping us to make our documentation better.

Google Analytics



### Cookie consent

We use cookies to measure the effectiveness of our documentation and whether users find what they're searching for. With your consent, you're helping us to make our documentation better.

Google Analytics





## Mode

1. DISABLED

2. AUTO

3. MANUAL

**Шаг 7.** Нажмите **Next**.

### Cookie consent

We use cookies to measure the effectiveness of our documentation and whether users find what they're searching for. With your consent, you're helping us to make our documentation better.

Google Analytics



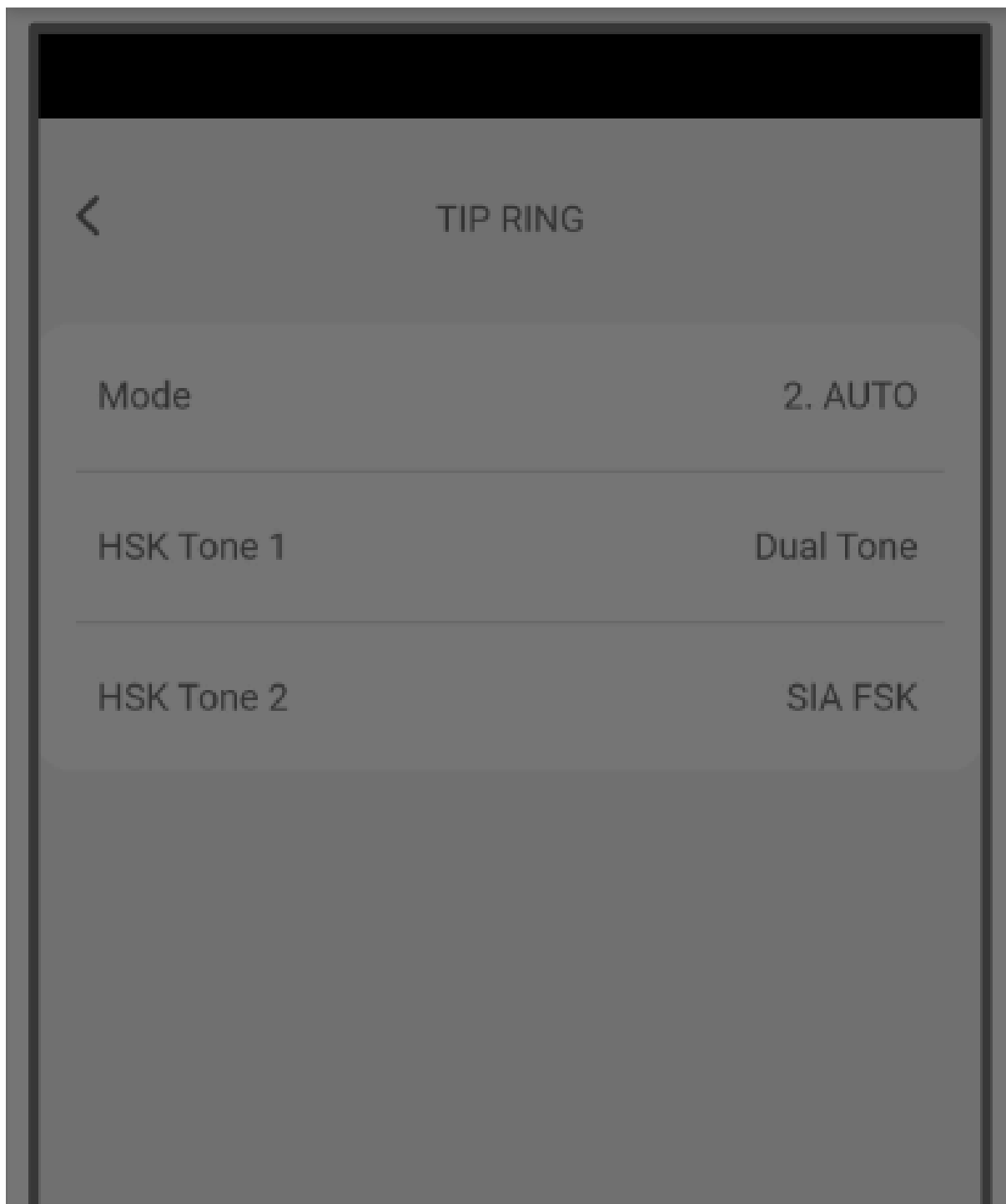

### Cookie consent

We use cookies to measure the effectiveness of our documentation and whether users find what they're searching for. With your consent, you're helping us to make our documentation better.

Google Analytics



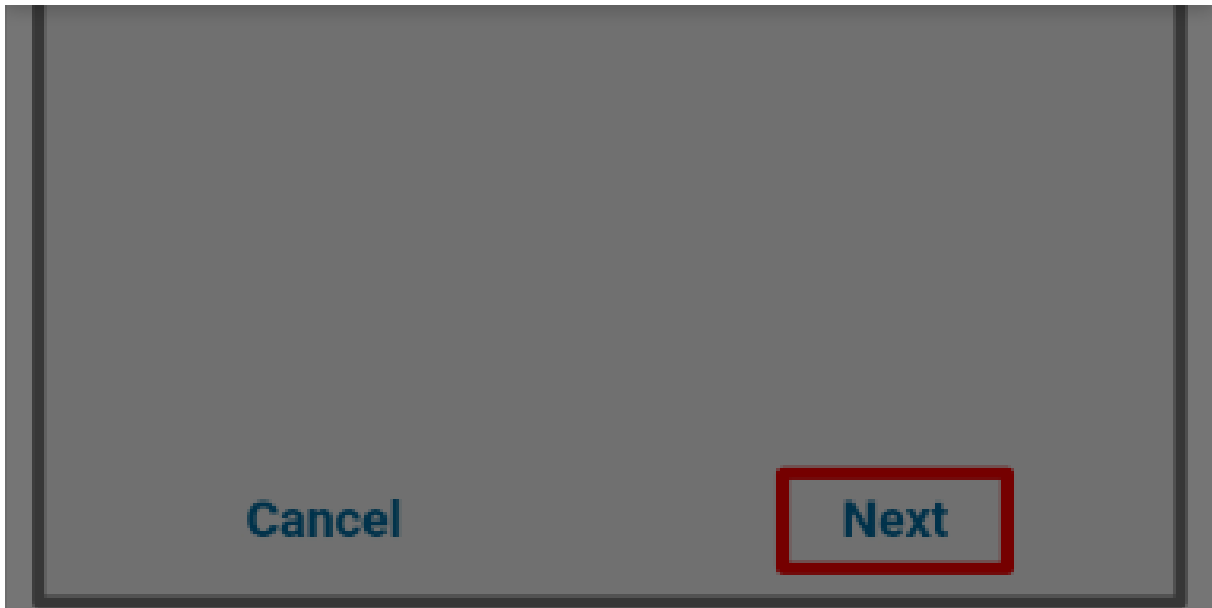

**Шаг 8.** Введите **Object ID** и **Module ID**, нажмите **Next**.

### Cookie consent

We use cookies to measure the effectiveness of our documentation and whether users find what they're searching for. With your consent, you're helping us to make our documentation better.

Google Analytics

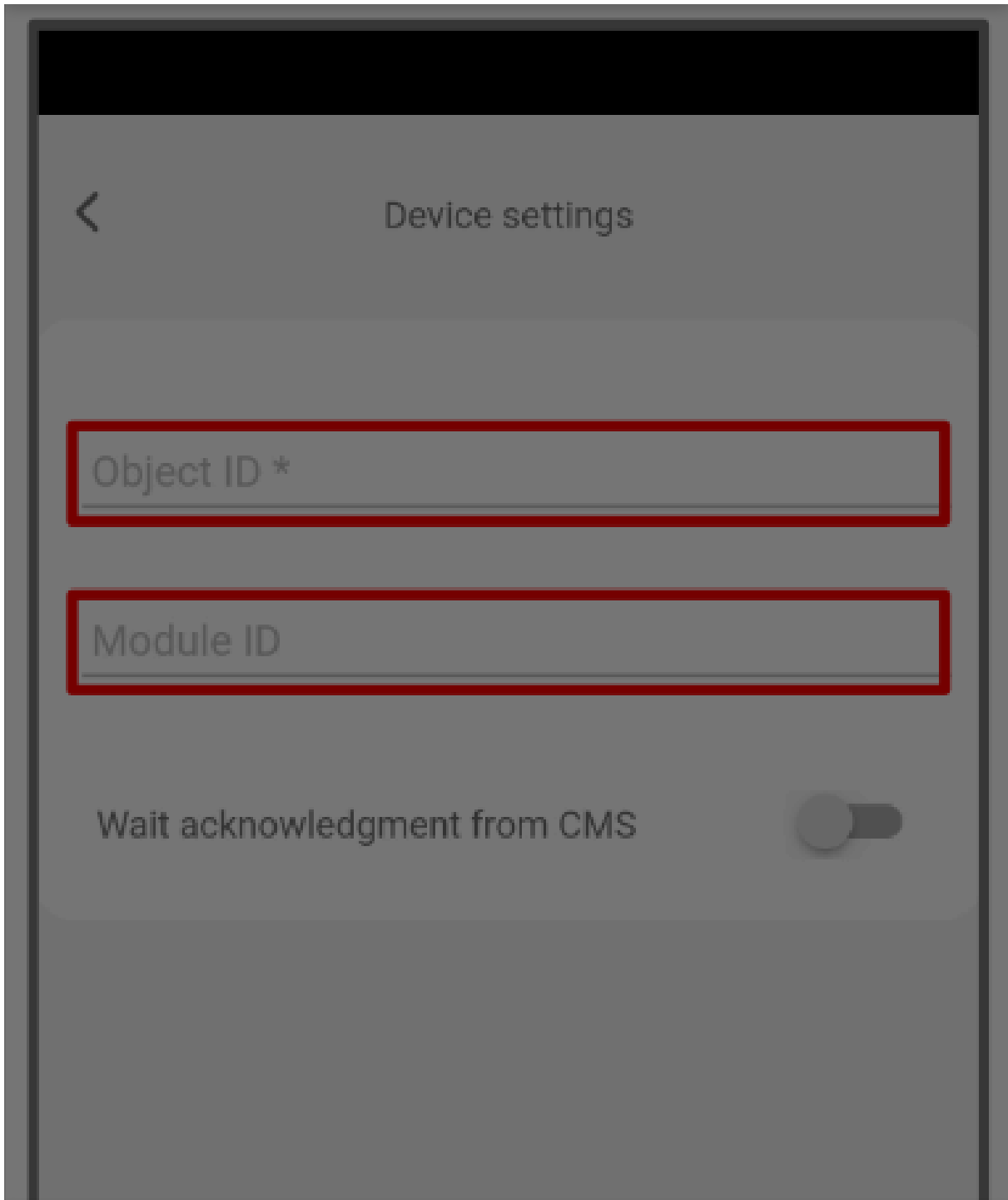

### Cookie consent

We use cookies to measure the effectiveness of our documentation and whether users find what they're searching for. With your consent, you're helping us to make our documentation better.

Google Analytics



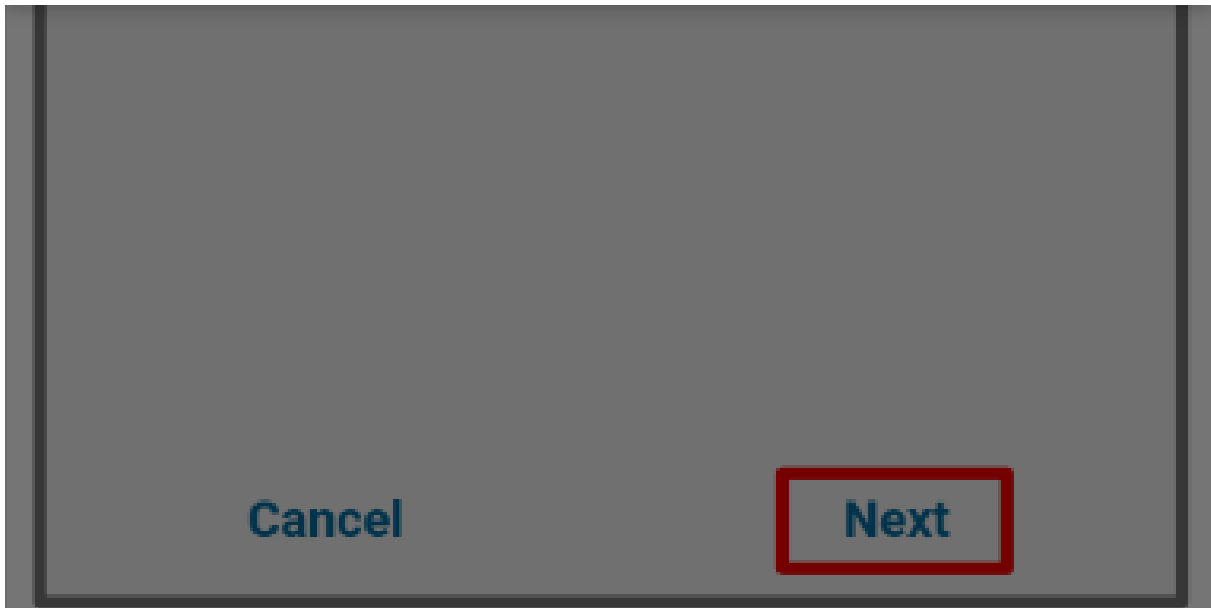

**Шаг 9.** Подождите, пока записываются данные.

### Cookie consent

We use cookies to measure the effectiveness of our documentation and whether users find what they're searching for. With your consent, you're helping us to make our documentation better.

Google Analytics



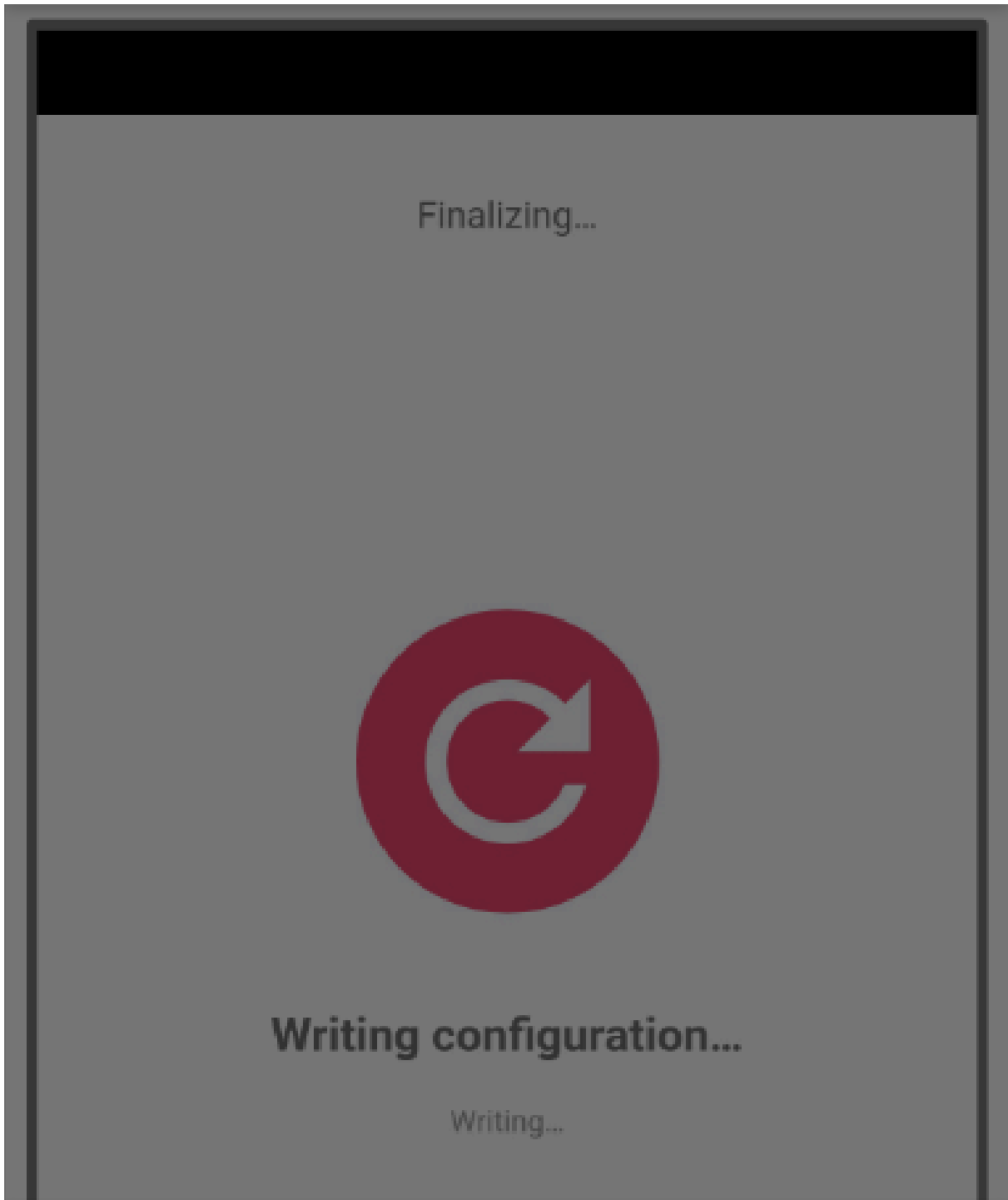

### Cookie consent

We use cookies to measure the effectiveness of our documentation and whether users find what they're searching for. With your consent, you're helping us to make our documentation better.

Google Analytics



Cancel

**Шаг 10.** Нажмите **Add to Protegus2**.

### Cookie consent

We use cookies to measure the effectiveness of our documentation and whether users find what they're searching for. With your consent, you're helping us to make our documentation better.

Google Analytics



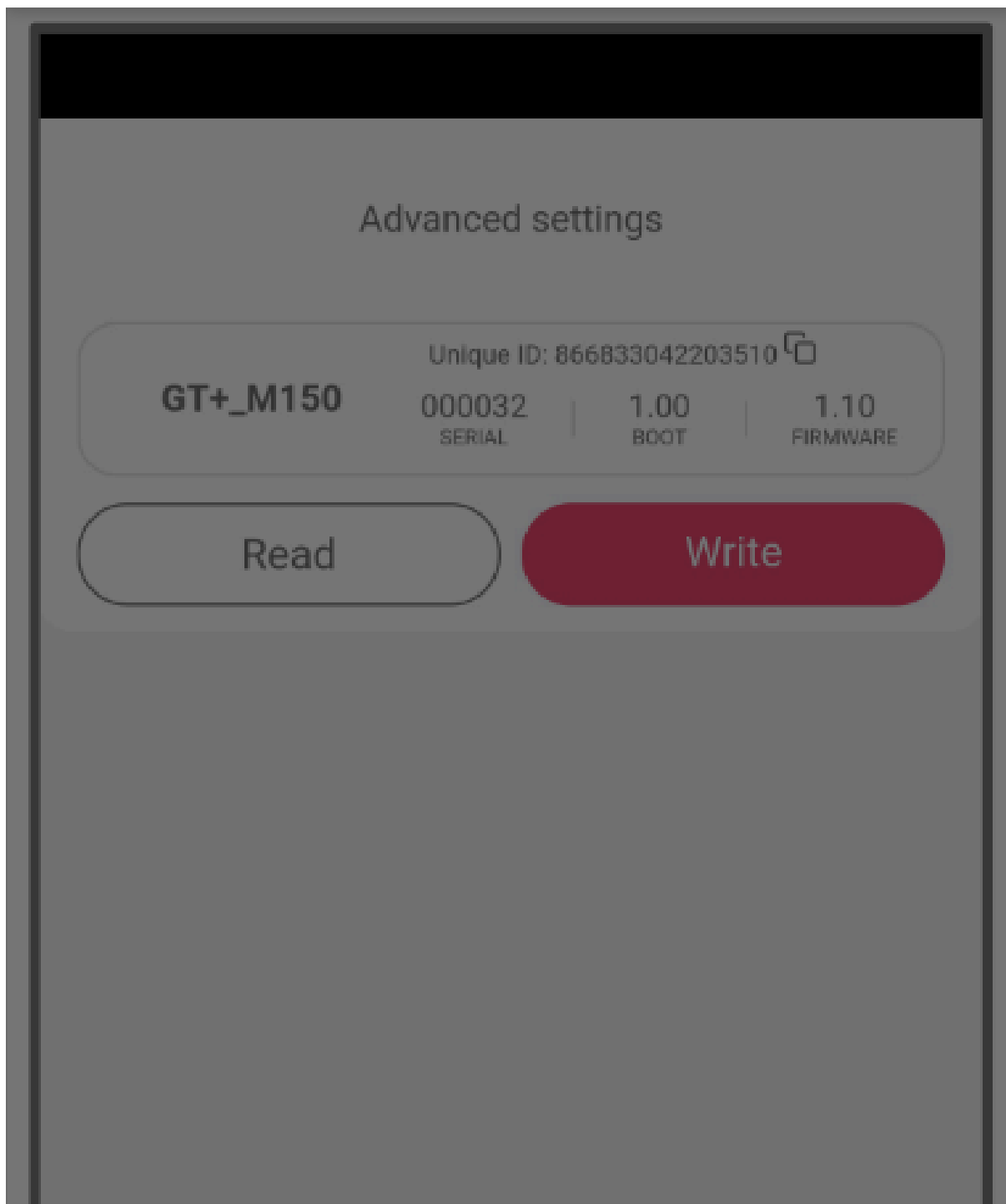

### Cookie consent

We use cookies to measure the effectiveness of our documentation and whether users find what they're searching for. With your consent, you're helping us to make our documentation better.

Google Analytics



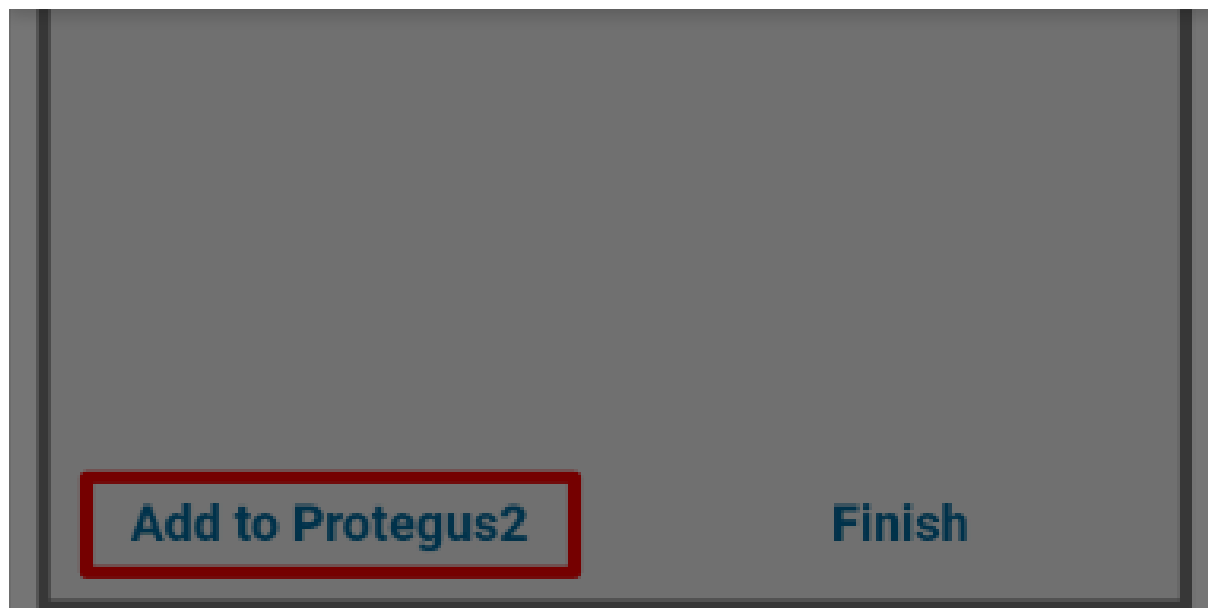

**Шаг 11.** Введите **Name** системы, нажмите **Next**.

### Cookie consent

We use cookies to measure the effectiveness of our documentation and whether users find what they're searching for. With your consent, you're helping us to make our documentation better.

Google Analytics



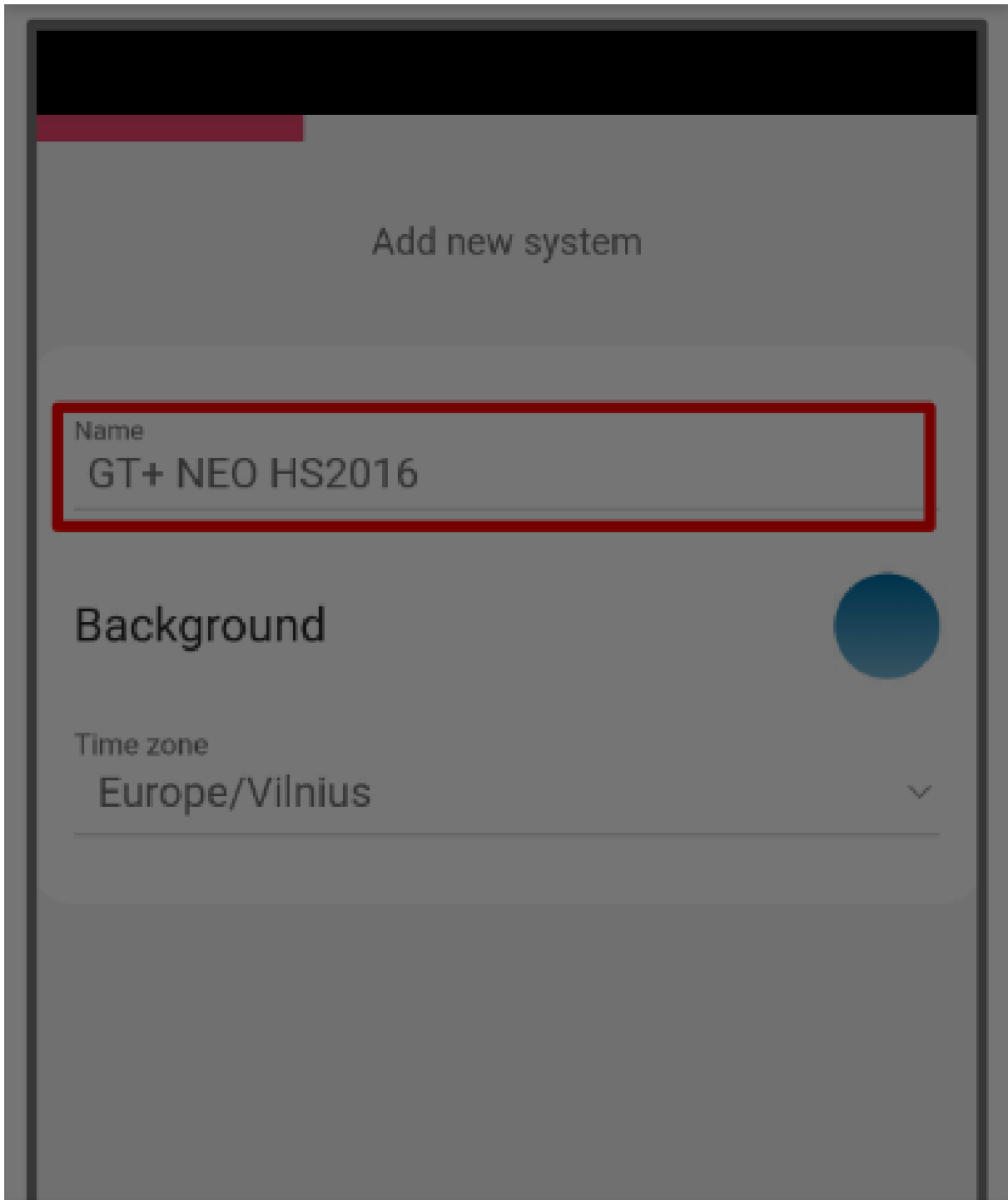

### Cookie consent

We use cookies to measure the effectiveness of our documentation and whether users find what they're searching for. With your consent, you're helping us to make our documentation better.

Google Analytics

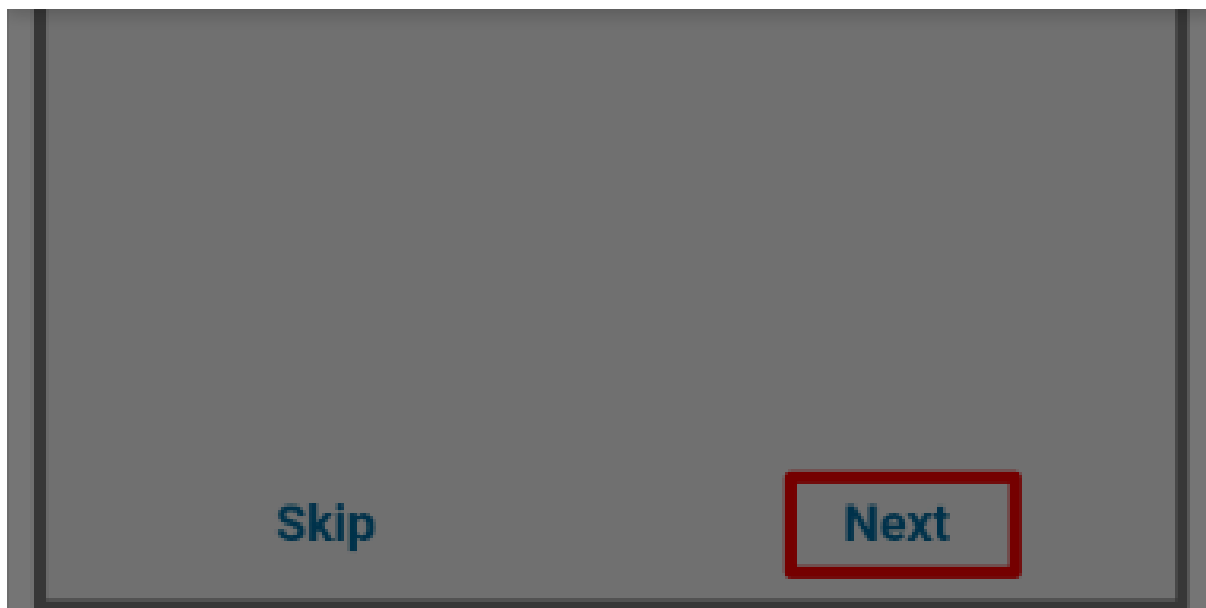

**Шаг 12.** Нажмите **Continue**.

### Cookie consent

We use cookies to measure the effectiveness of our documentation and whether users find what they're searching for. With your consent, you're helping us to make our documentation better.

Google Analytics



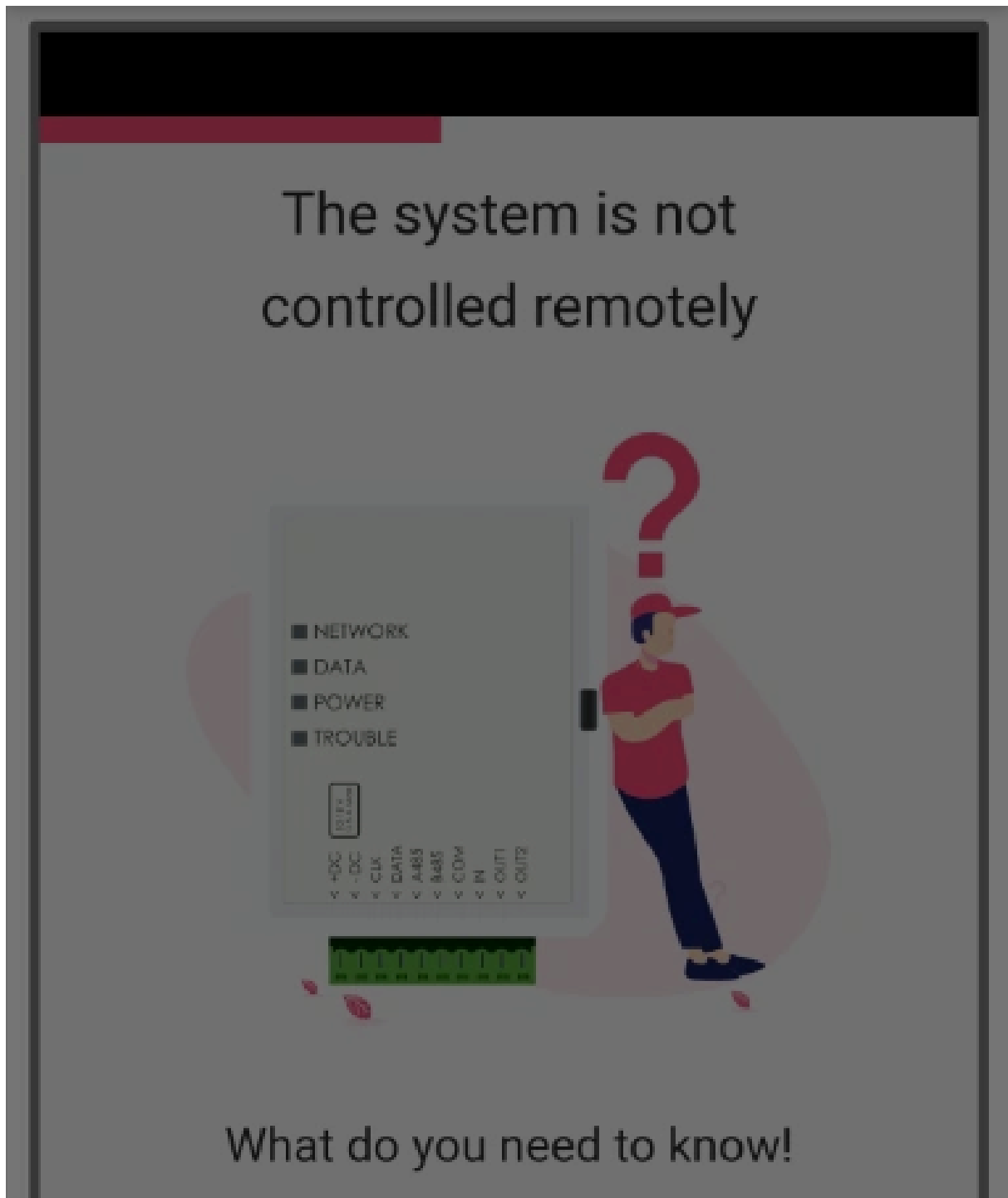

### Cookie consent

We use cookies to measure the effectiveness of our documentation and whether users find what they're searching for. With your consent, you're helping us to make our documentation better.

- Google Analytics



Continue

**Шаг 13.** Введите **Area name**. Включите **Control with Protegus2**.

### Cookie consent

We use cookies to measure the effectiveness of our documentation and whether users find what they're searching for. With your consent, you're helping us to make our documentation better.

Google Analytics



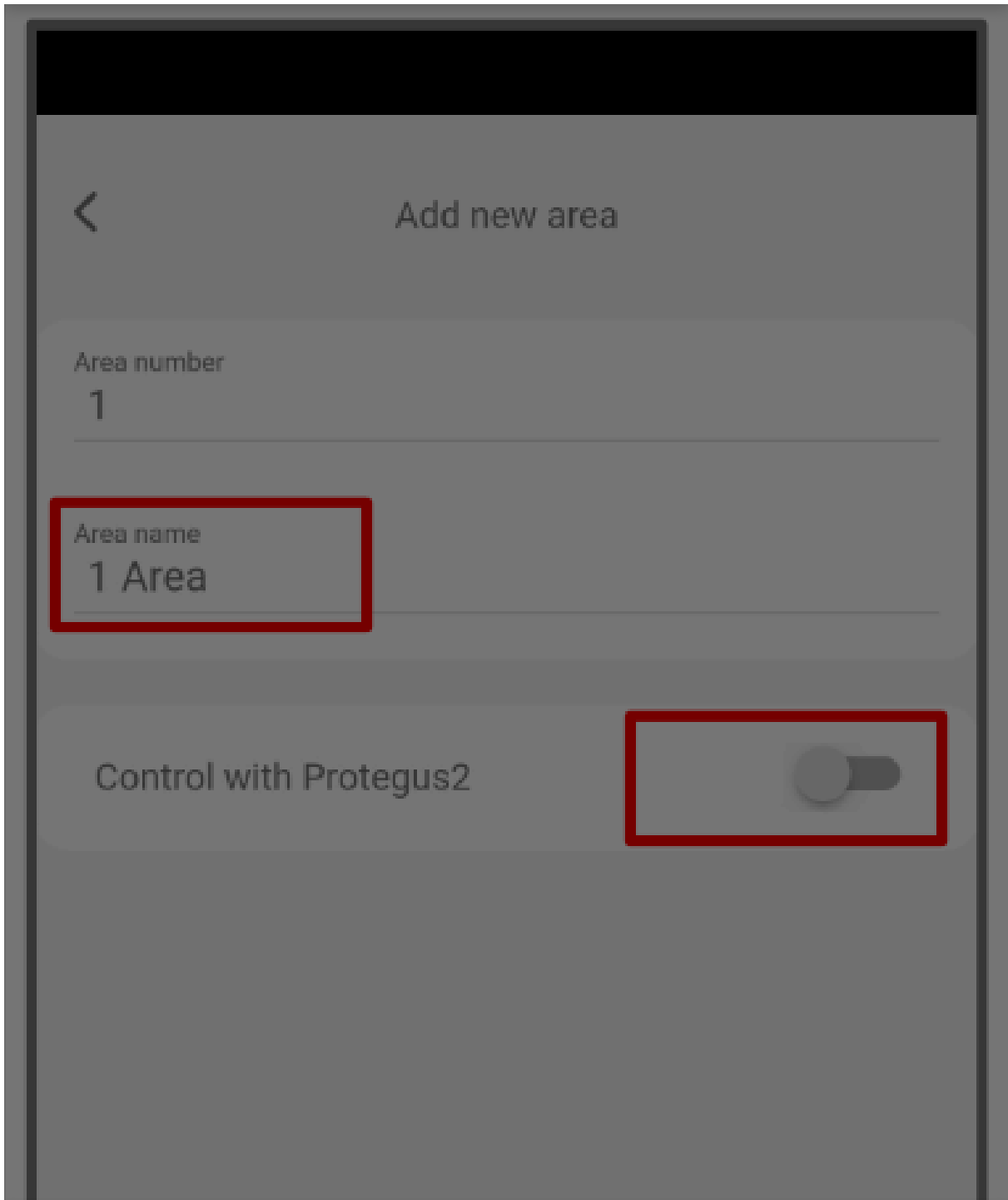

### Cookie consent

We use cookies to measure the effectiveness of our documentation and whether users find what they're searching for. With your consent, you're helping us to make our documentation better.

Google Analytics



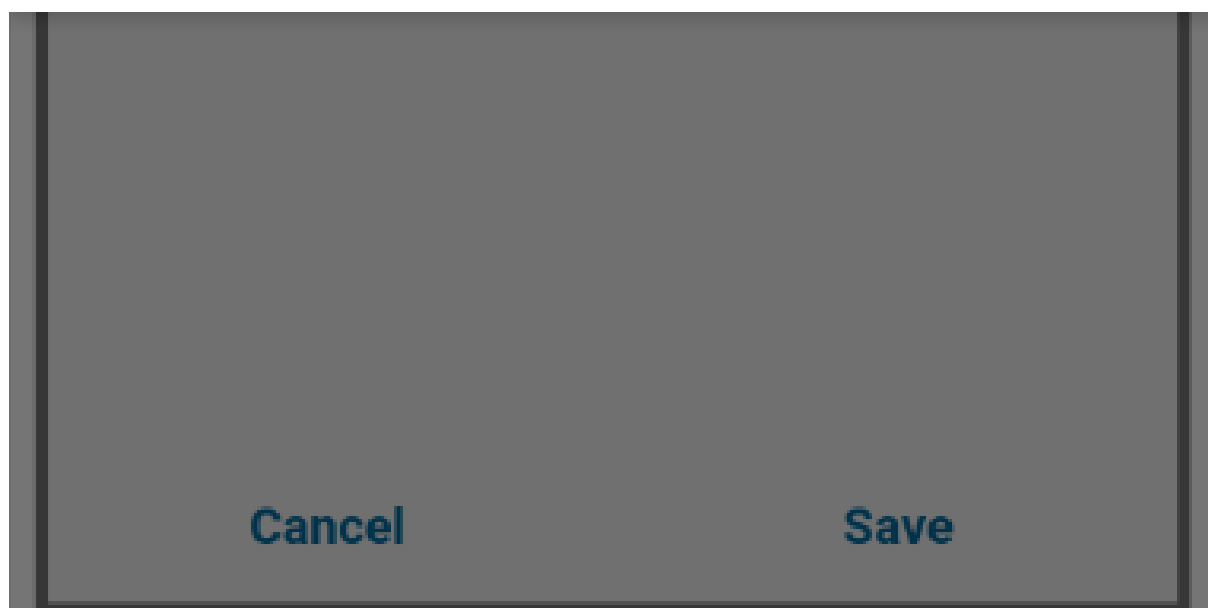

**Шаг 14.** Выберите выход PGM. Нажмите **Save**.

### Cookie consent

We use cookies to measure the effectiveness of our documentation and whether users find what they're searching for. With your consent, you're helping us to make our documentation better.

Google Analytics



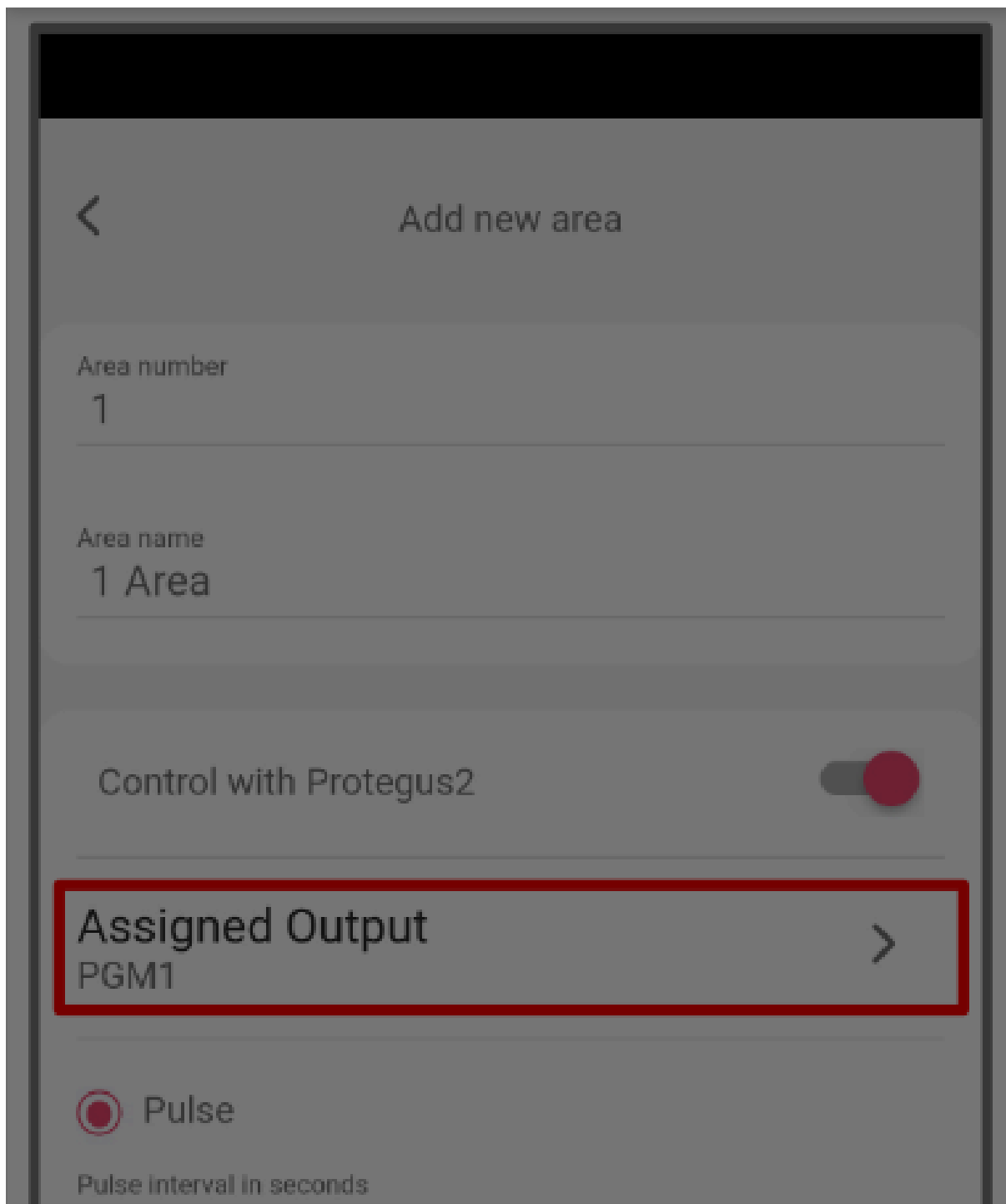

### Cookie consent

We use cookies to measure the effectiveness of our documentation and whether users find what they're searching for. With your consent, you're helping us to make our documentation better.

Google Analytics



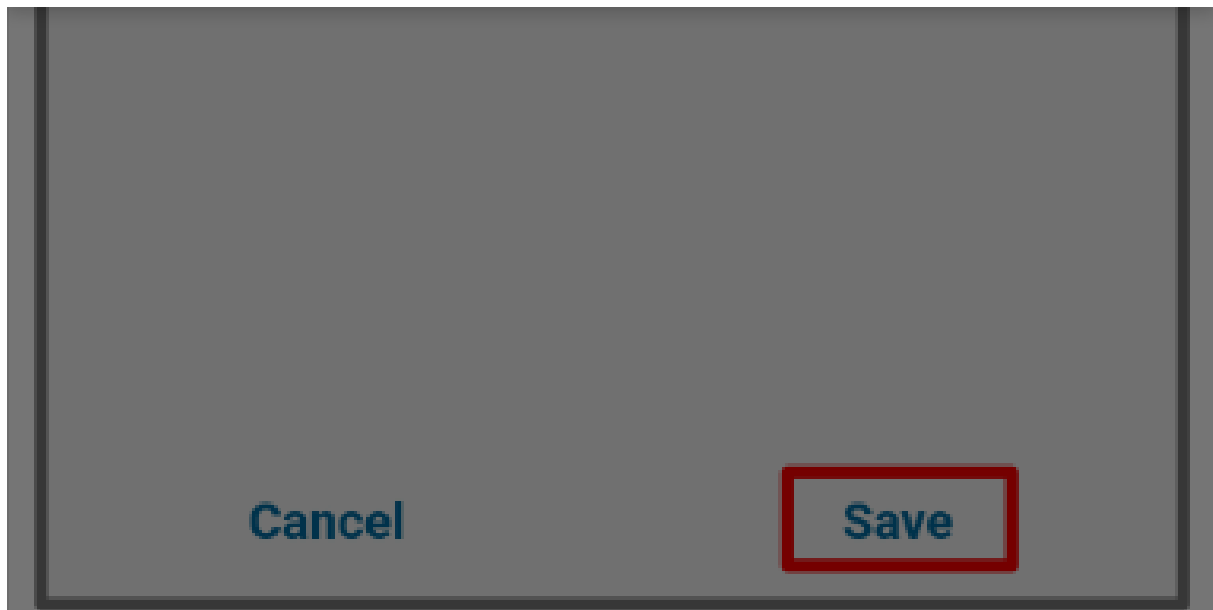

**Шаг 15.** Нажмите **Next**.

### Cookie consent

We use cookies to measure the effectiveness of our documentation and whether users find what they're searching for. With your consent, you're helping us to make our documentation better.

Google Analytics



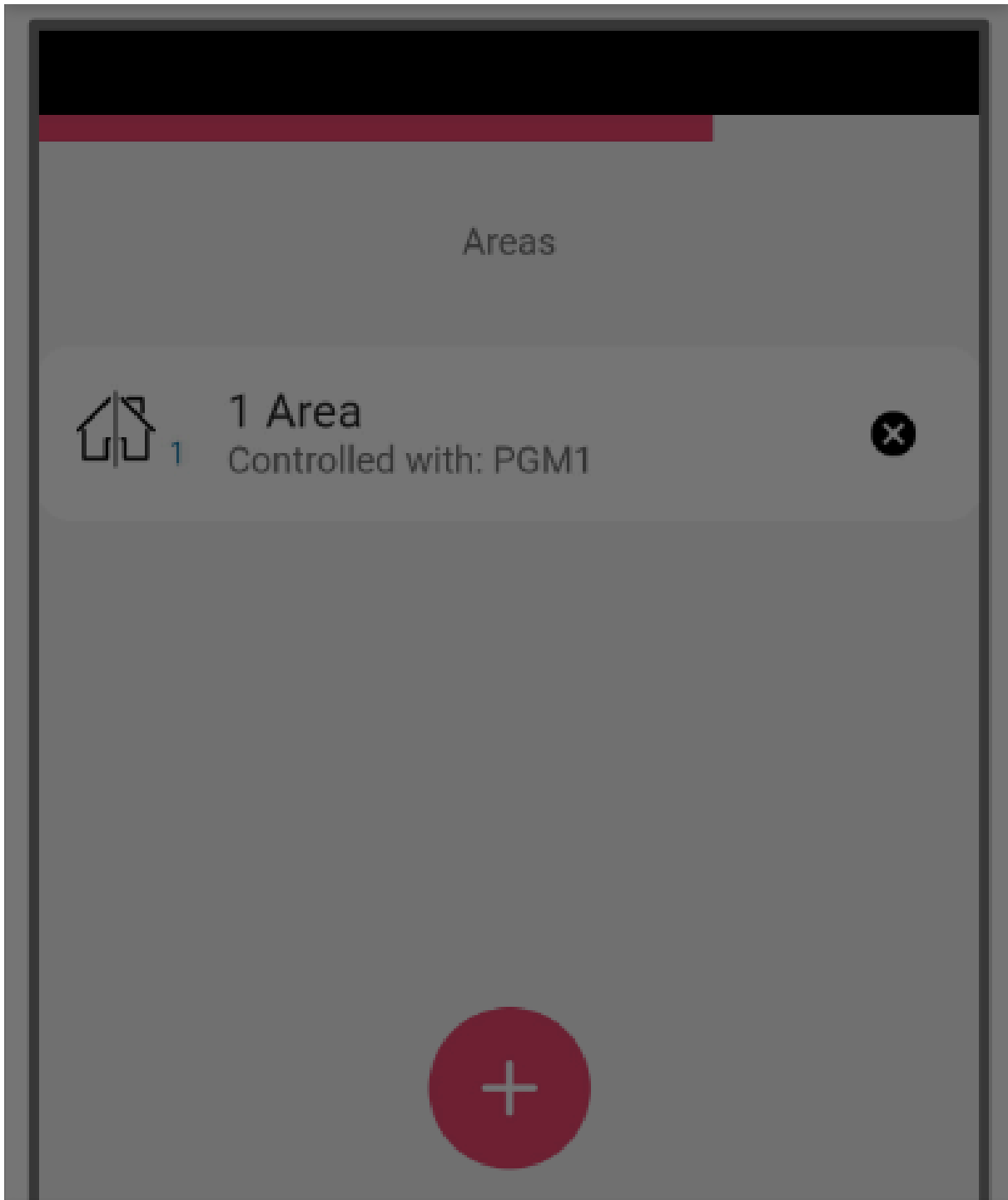

### Cookie consent

We use cookies to measure the effectiveness of our documentation and whether users find what they're searching for. With your consent, you're helping us to make our documentation better.

Google Analytics



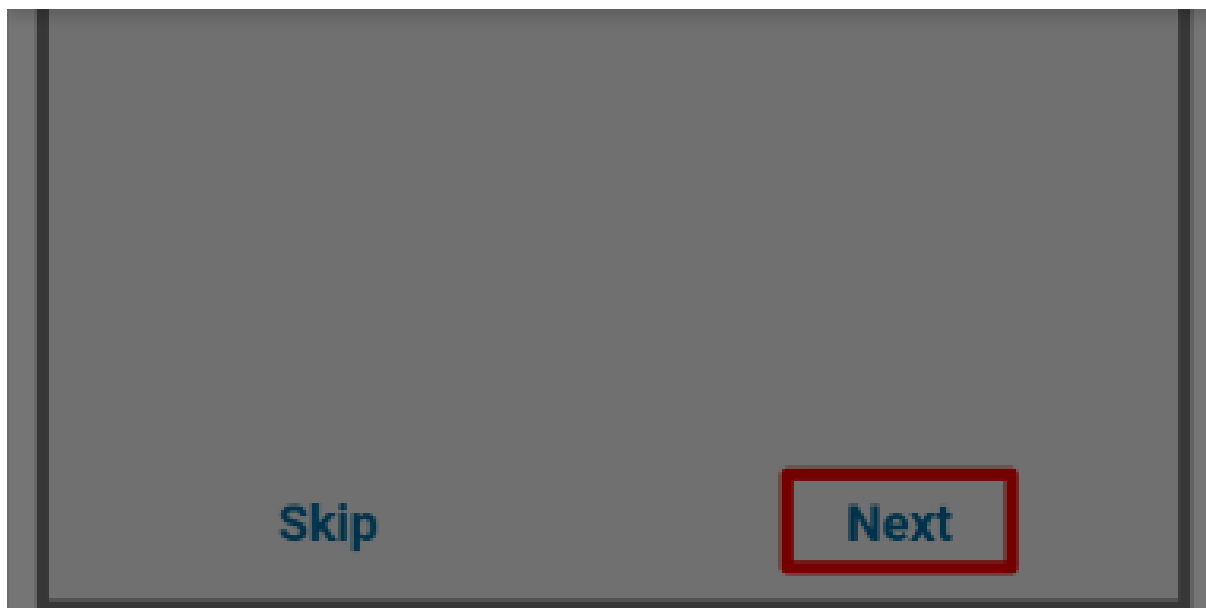

**Шаг 16.** Нажмите **Add**.

### Cookie consent

We use cookies to measure the effectiveness of our documentation and whether users find what they're searching for. With your consent, you're helping us to make our documentation better.

Google Analytics



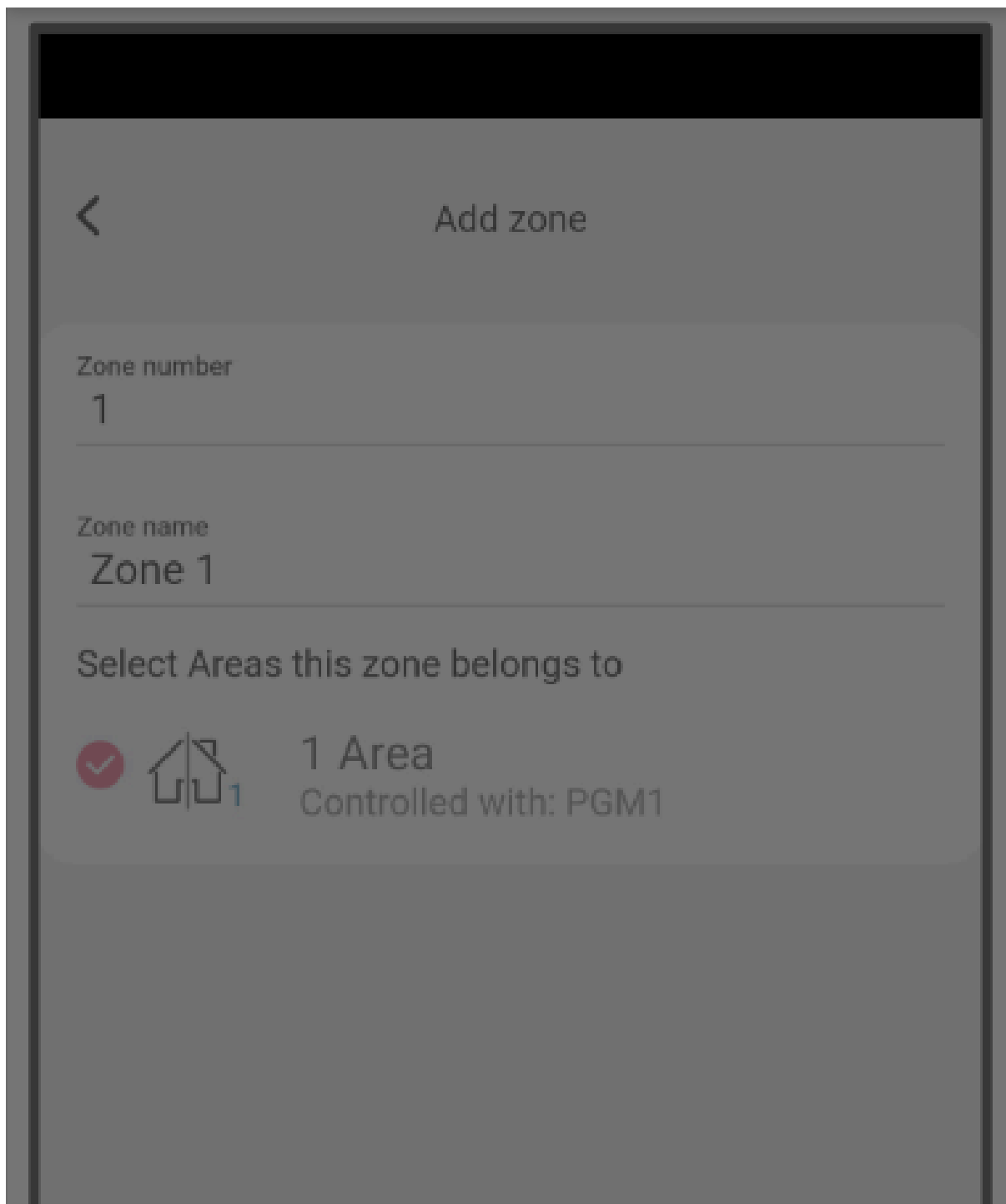

### Cookie consent

We use cookies to measure the effectiveness of our documentation and whether users find what they're searching for. With your consent, you're helping us to make our documentation better.

Google Analytics



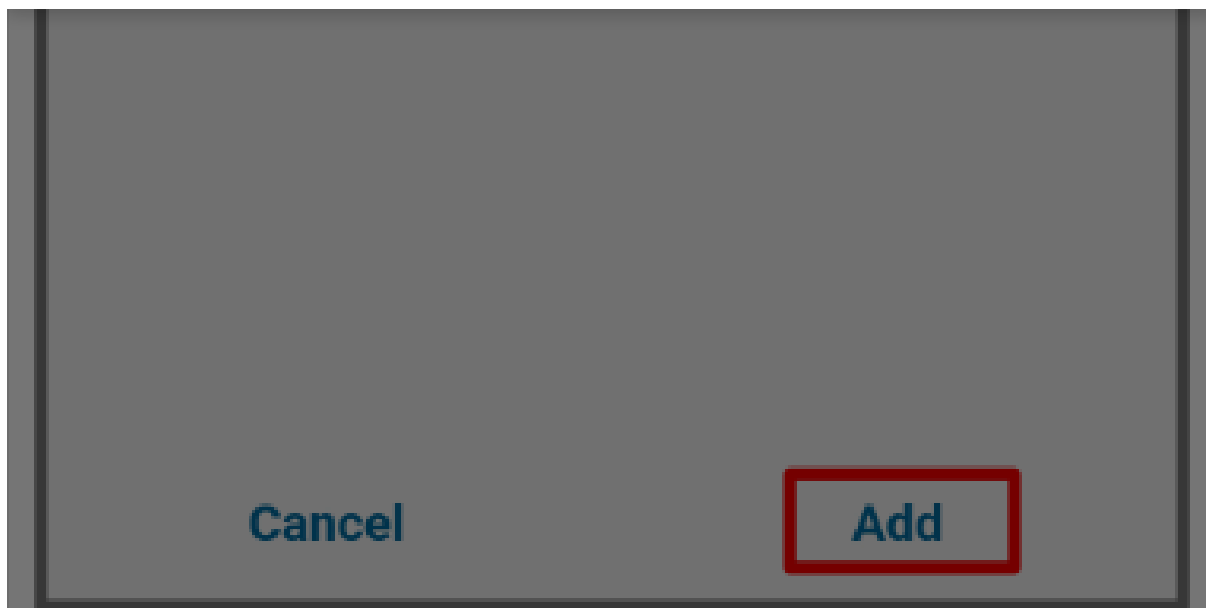

**Шаг 17.** Нажмите **Done**.

### Cookie consent

We use cookies to measure the effectiveness of our documentation and whether users find what they're searching for. With your consent, you're helping us to make our documentation better.

Google Analytics



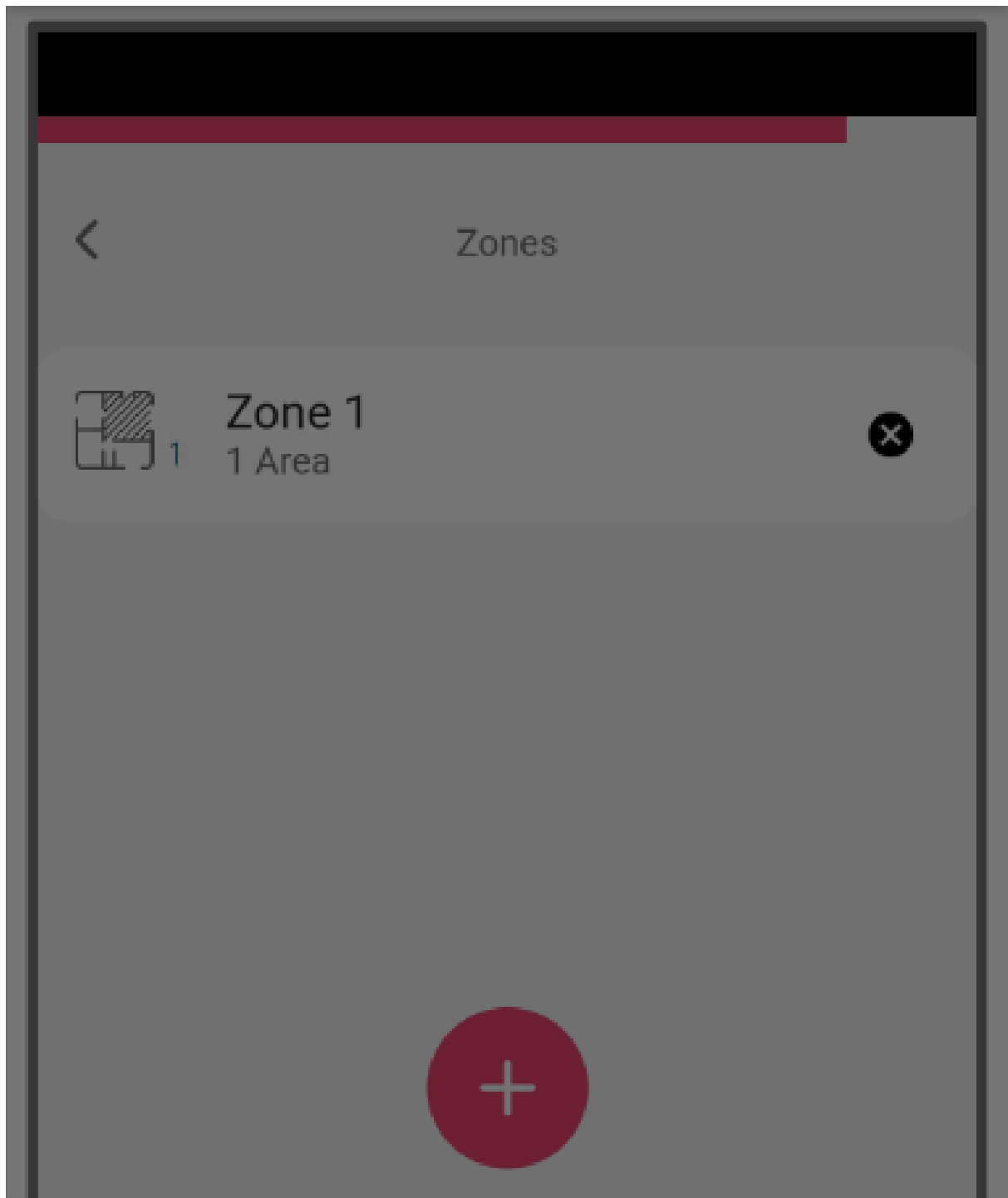

### Cookie consent

We use cookies to measure the effectiveness of our documentation and whether users find what they're searching for. With your consent, you're helping us to make our documentation better.

Google Analytics



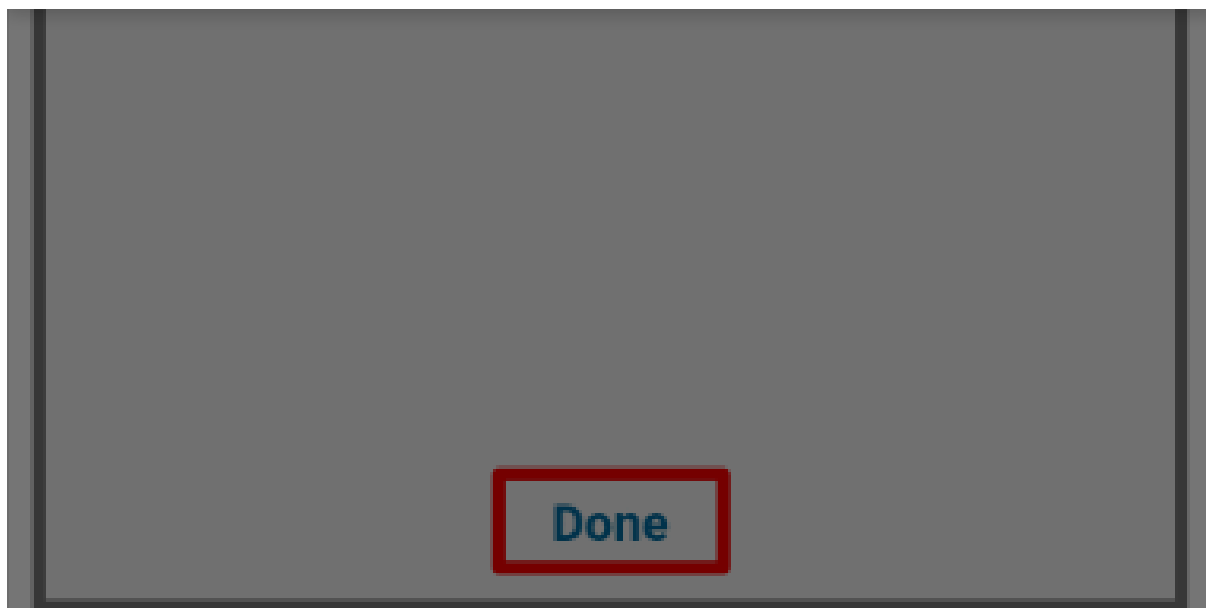

**Шаг 18.** Нажмите **Finish**.

### Cookie consent

We use cookies to measure the effectiveness of our documentation and whether users find what they're searching for. With your consent, you're helping us to make our documentation better.

Google Analytics



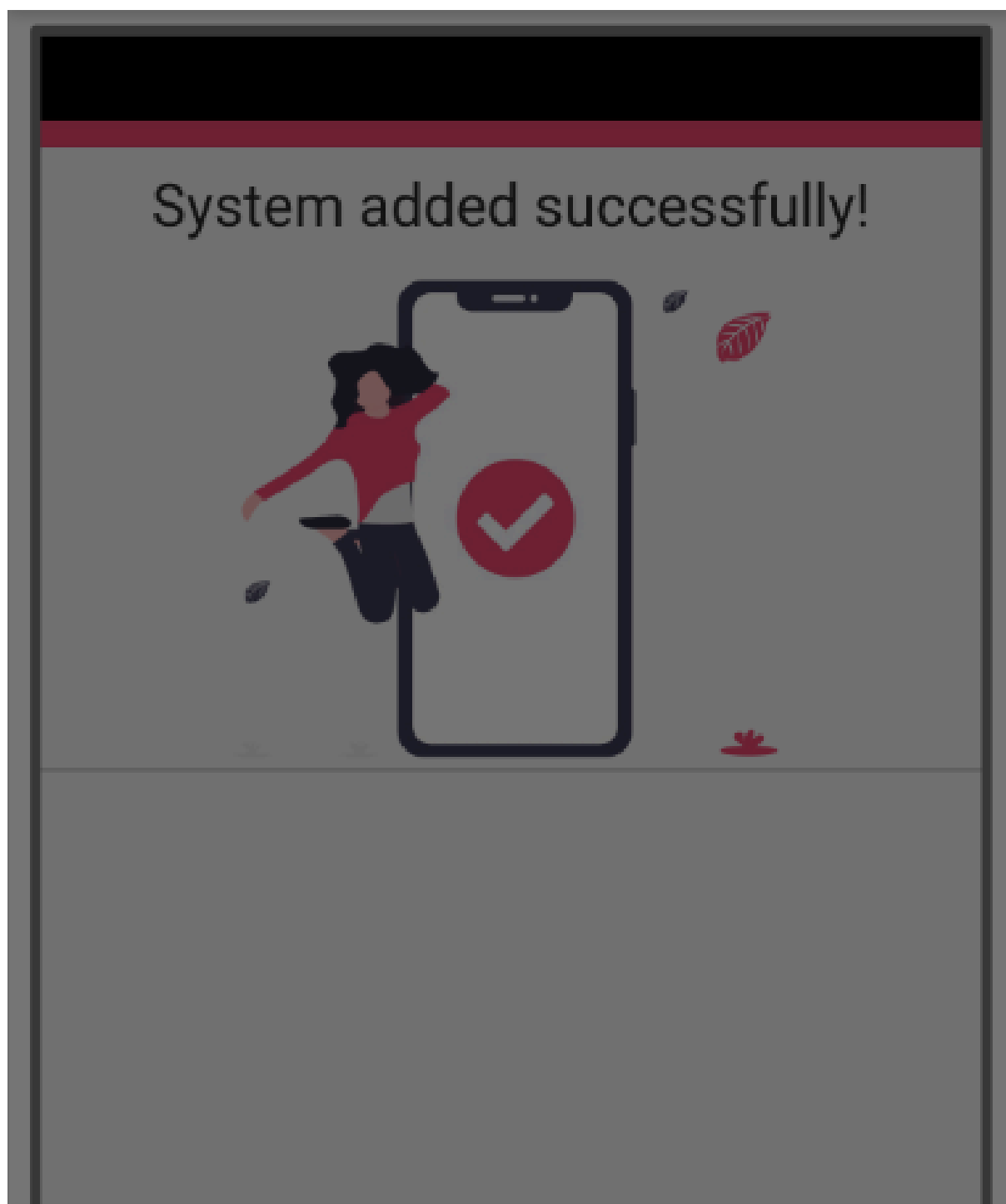

### Cookie consent

We use cookies to measure the effectiveness of our documentation and whether users find what they're searching for. With your consent, you're helping us to make our documentation better.

Google Analytics





Finish

**Шаг 19.** Нажмите на систему.

### Cookie consent

We use cookies to measure the effectiveness of our documentation and whether users find what they're searching for. With your consent, you're helping us to make our documentation better.

Google Analytics





### Cookie consent

We use cookies to measure the effectiveness of our documentation and whether users find what they're searching for. With your consent, you're helping us to make our documentation better.

Google Analytics





**Шаг 20.** Подождите 1 минуту для завершения и нажмите **Transfer**.

### Cookie consent

We use cookies to measure the effectiveness of our documentation and whether users find what they're searching for. With your consent, you're helping us to make our documentation better.

Google Analytics



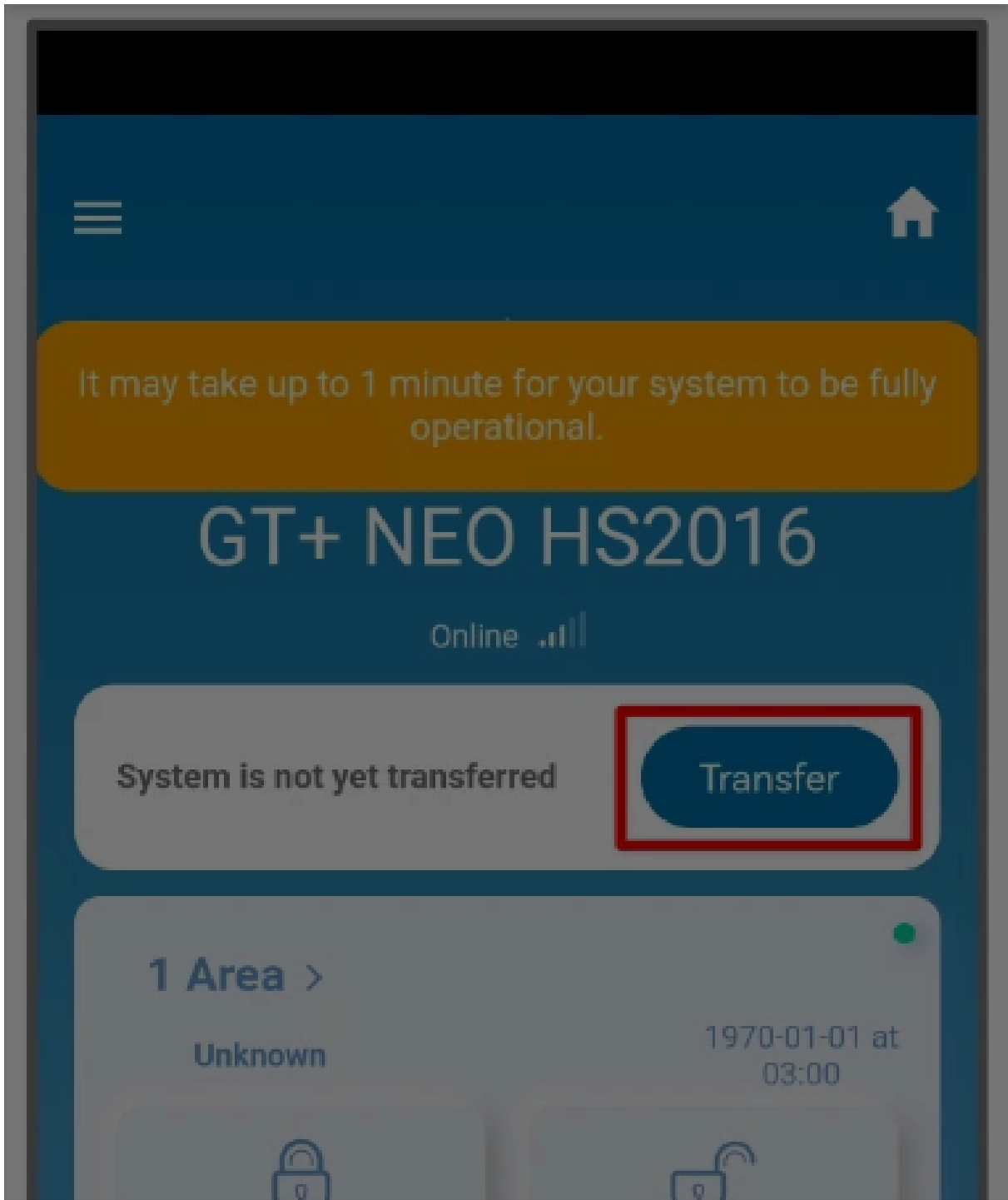

### Cookie consent

We use cookies to measure the effectiveness of our documentation and whether users find what they're searching for. With your consent, you're helping us to make our documentation better.

Google Analytics



**Шаг 21.** Введите e-mail пользователя, которому установщик передаст систему.  
Нажмите **Transfer**.

### Cookie consent

We use cookies to measure the effectiveness of our documentation and whether users find what they're searching for. With your consent, you're helping us to make our documentation better.

Google Analytics



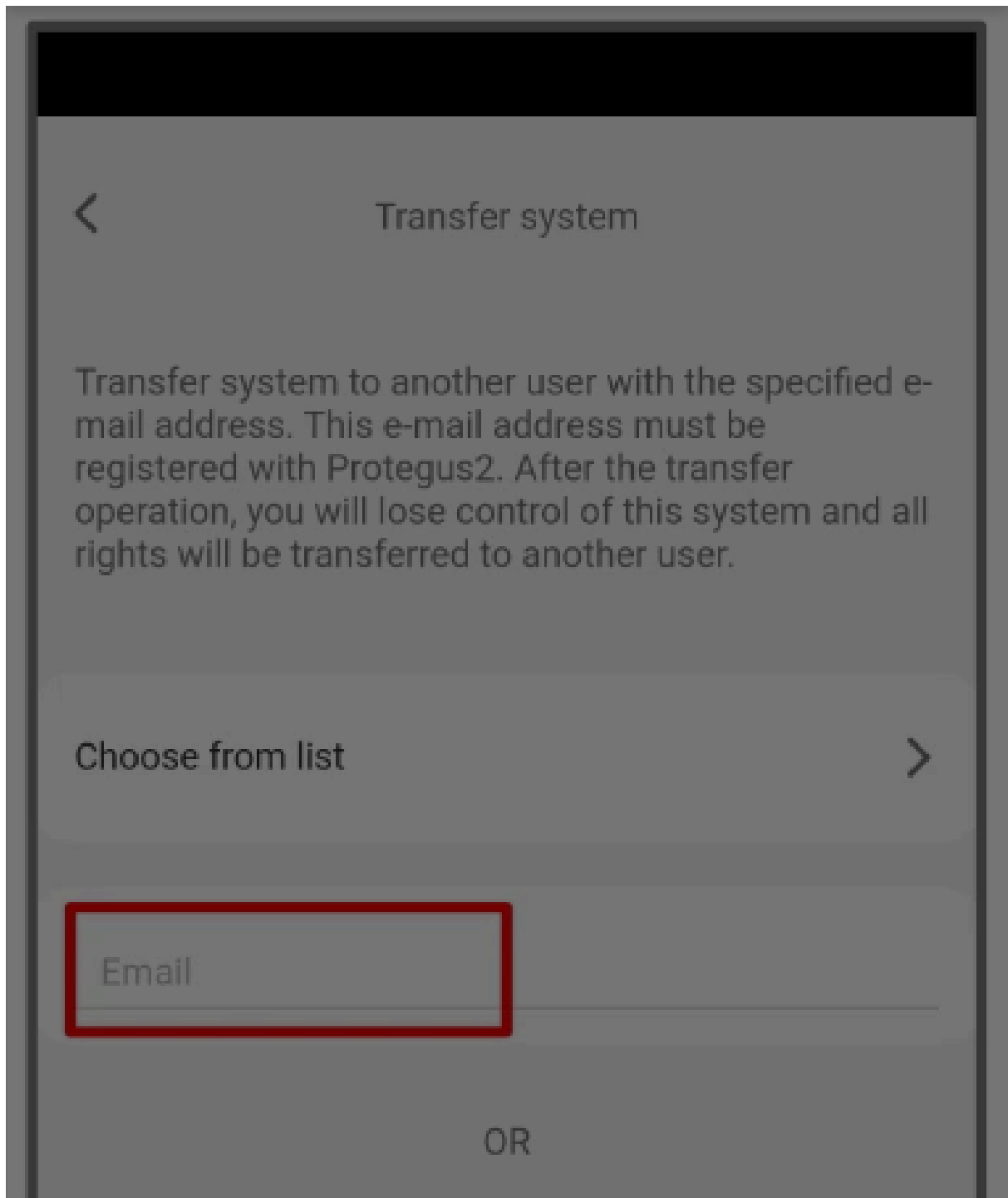

### Cookie consent

We use cookies to measure the effectiveness of our documentation and whether users find what they're searching for. With your consent, you're helping us to make our documentation better.

Google Analytics





Transfer

**Шаг 22.** Система появится в Protegus на телефоне пользователя.

### Cookie consent

We use cookies to measure the effectiveness of our documentation and whether users find what they're searching for. With your consent, you're helping us to make our documentation better.

Google Analytics



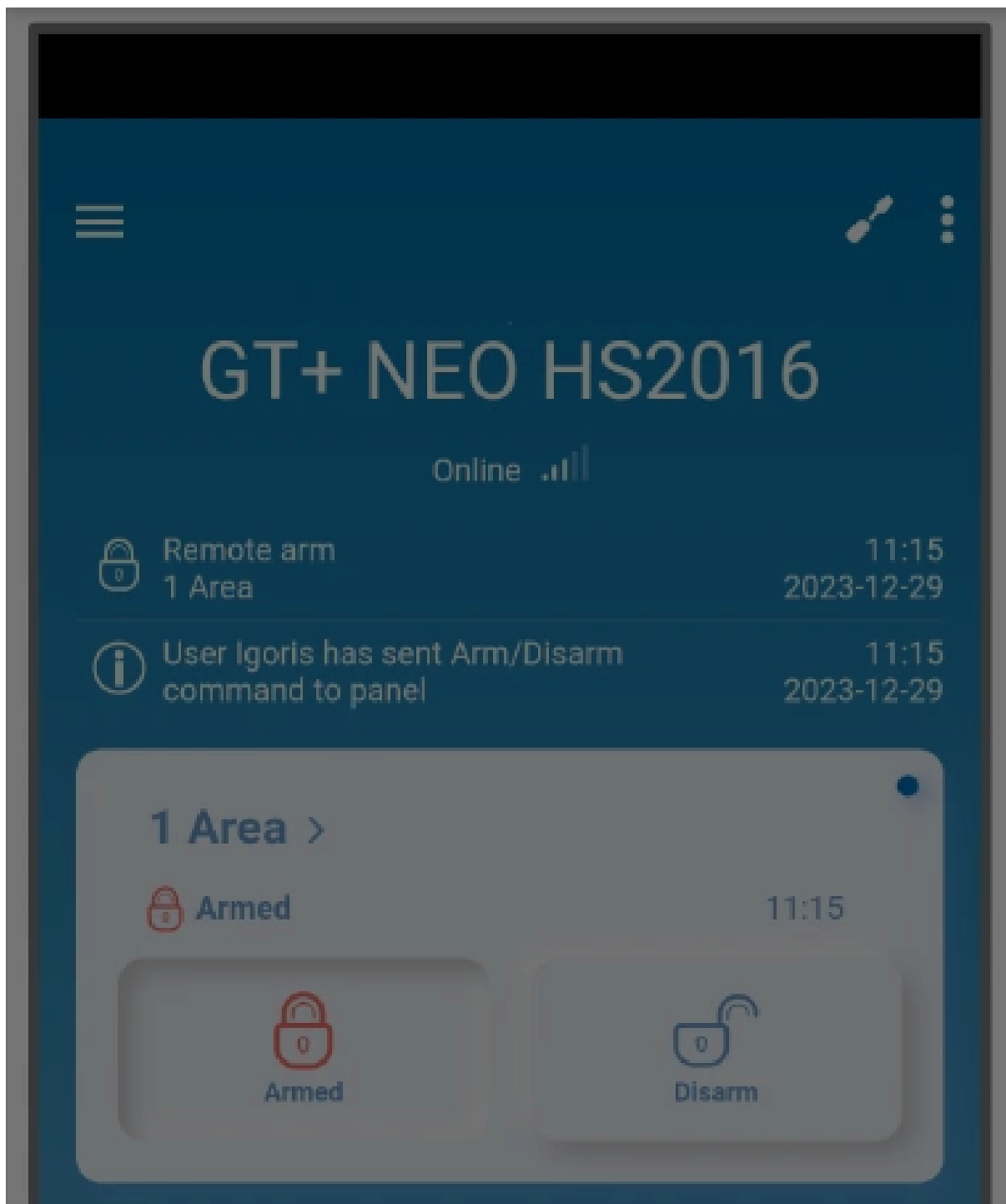

### Cookie consent

We use cookies to measure the effectiveness of our documentation and whether users find what they're searching for. With your consent, you're helping us to make our documentation better.

Google Analytics



## СОВЕТ

После завершения установки и настройки выполните проверку системы:

1. Создайте событие:

- поставьте/снимите систему с охраны с клавиатуры панели управления.
- вызовите тревогу зоны при включенной охране.

2. Убедитесь, что событие поступает в CMS (Central Monitoring Station) и в приложение Protegus2.

### Cookie consent

We use cookies to measure the effectiveness of our documentation and whether users find what they're searching for. With your consent, you're helping us to make our documentation better.

Google Analytics

