

КОММУНИКАТОРЫ

Innerrange Inception with GT/GT+/GET quick setup



GT product image

GT



GT+ product image

GT+



GET product image

GET

Short wiring and programming steps to connect the GT/GT+/GET communicator to an Innerrange Inception panel using serial connection, then enroll the system in Protegus2. Use this alongside the full manuals for all other settings. (Terminal labels differ slightly between GT/GT+/GET, but the connections are the same.)



CAUTION

Install and service only by qualified personnel. Disconnect power before wiring. Unauthorized changes void warranty.

1. Prerequisites

1. GT/GT+/GET firmware 1.21, SIM inserted, PIN disabled, data plan active.
2. Innerrange Inception panel with internet access and firmware version **2.3.0.3507-r0** or higher.
3. Inner Range USB cable, part number 993030USB .
4. CMS account number if reporting to CMS.
5. Protegus2 company/installer account and communicator IMEI.

Cookie consent

We use cookies to measure the effectiveness of our documentation and whether users find what they're searching for. With your consent, you're helping us to make our documentation better.



Google Analytics

Accept

Reject



GT/GT+/GET terminal	Innerrange Inception panel / cable	Notes
+12V DC	VOUT +	Panel power
-12V DC	0V and black wire from cable 993030USB	Panel ground
CLK	green wire from cable 993030USB	Serial connection
DATA	white wire from cable 993030USB	Serial connection

INNERRANGE INCEPTION panel connection diagram

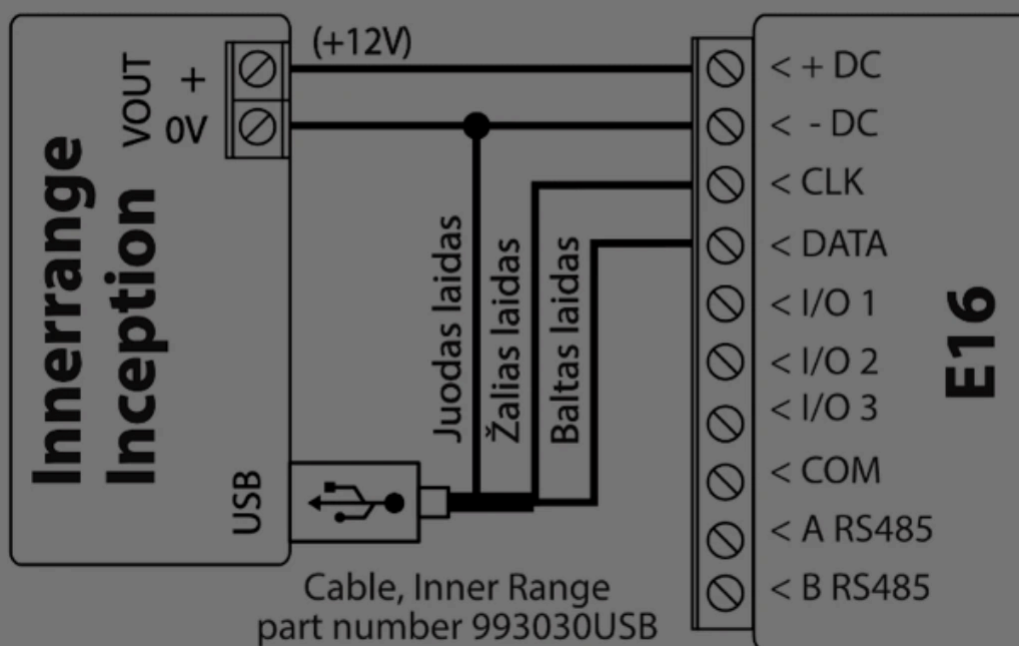

3. Programming the Innerrange Inception Alarm Panel

1. Make sure the Innerrange Inception panel has firmware version **2.3.0.3507-r0** or higher and is connected to the internet.
2. In a browser, connect to <https://skytunnel.com.au/inception/SERIALNUMBER>, where

Cookie consent

We use cookies to measure the effectiveness of our documentation and whether users find what they're searching for. With your consent, you're helping us to make our documentation better.

Google Analytics

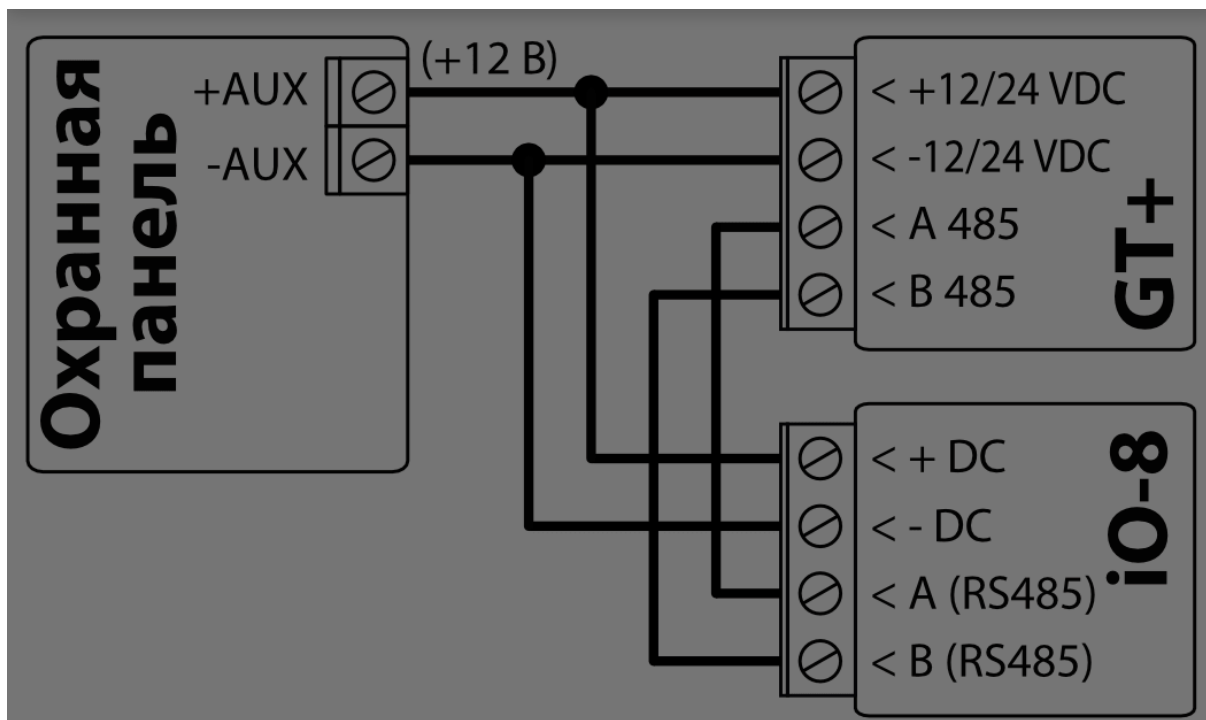

5. Tick **Enable 3rd Party Device Reporting**.
6. Set **3rd Party Device Type** to **Trikdis**.
7. Set **Serial port** to **Serial Port 1 (Plugged In, In Use By 3rd Party Device)**.
8. Save settings and exit the application.

4. Add system to Protegus2

Step 1. Tap Add new system.

Cookie consent

We use cookies to measure the effectiveness of our documentation and whether users find what they're searching for. With your consent, you're helping us to make our documentation better.

Google Analytics

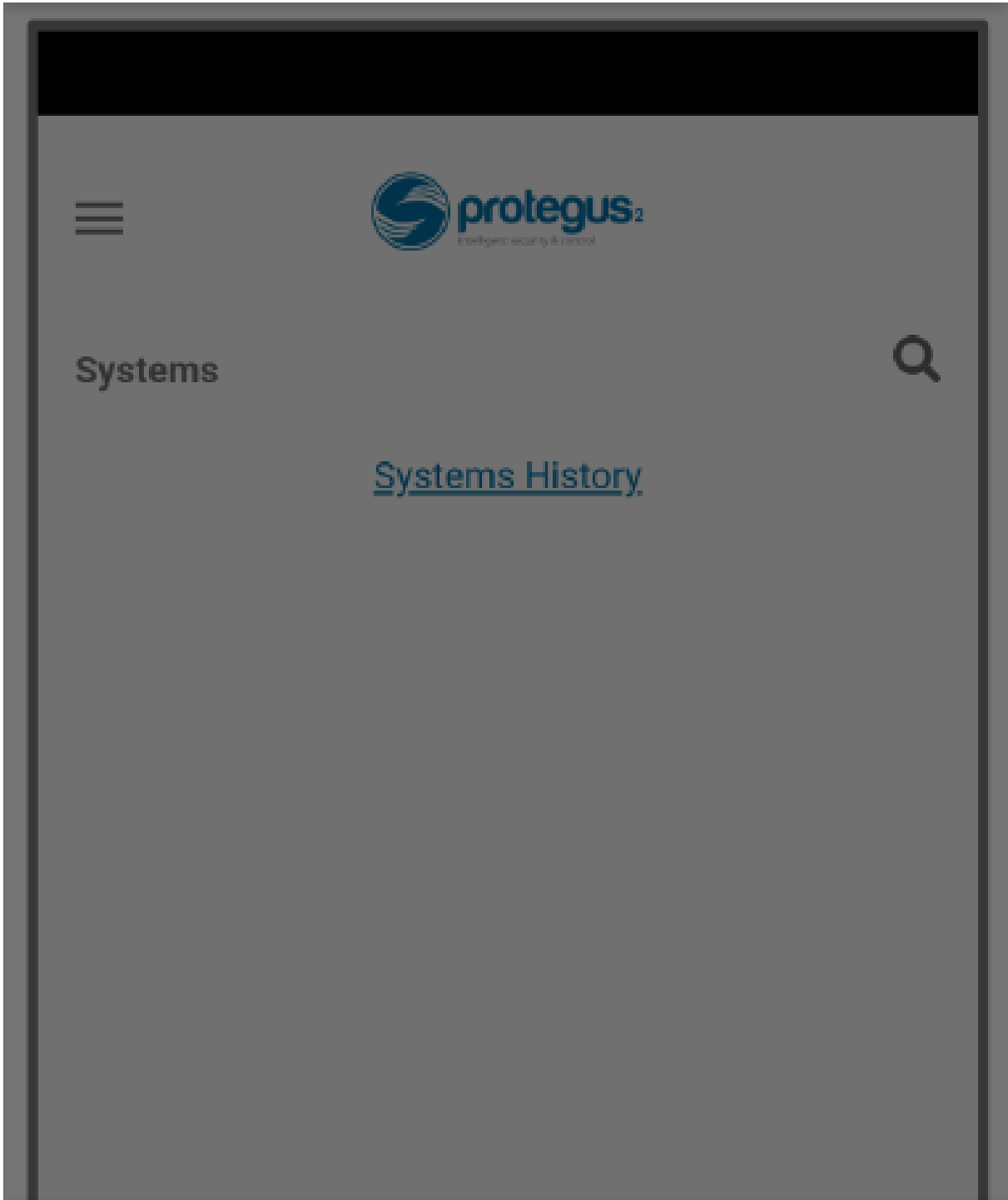

Cookie consent

We use cookies to measure the effectiveness of our documentation and whether users find what they're searching for. With your consent, you're helping us to make our documentation better.

- Google Analytics





Step 2. Enter the communicator **IMEI**, tap **Next**.

Cookie consent

We use cookies to measure the effectiveness of our documentation and whether users find what they're searching for. With your consent, you're helping us to make our documentation better.

Google Analytics



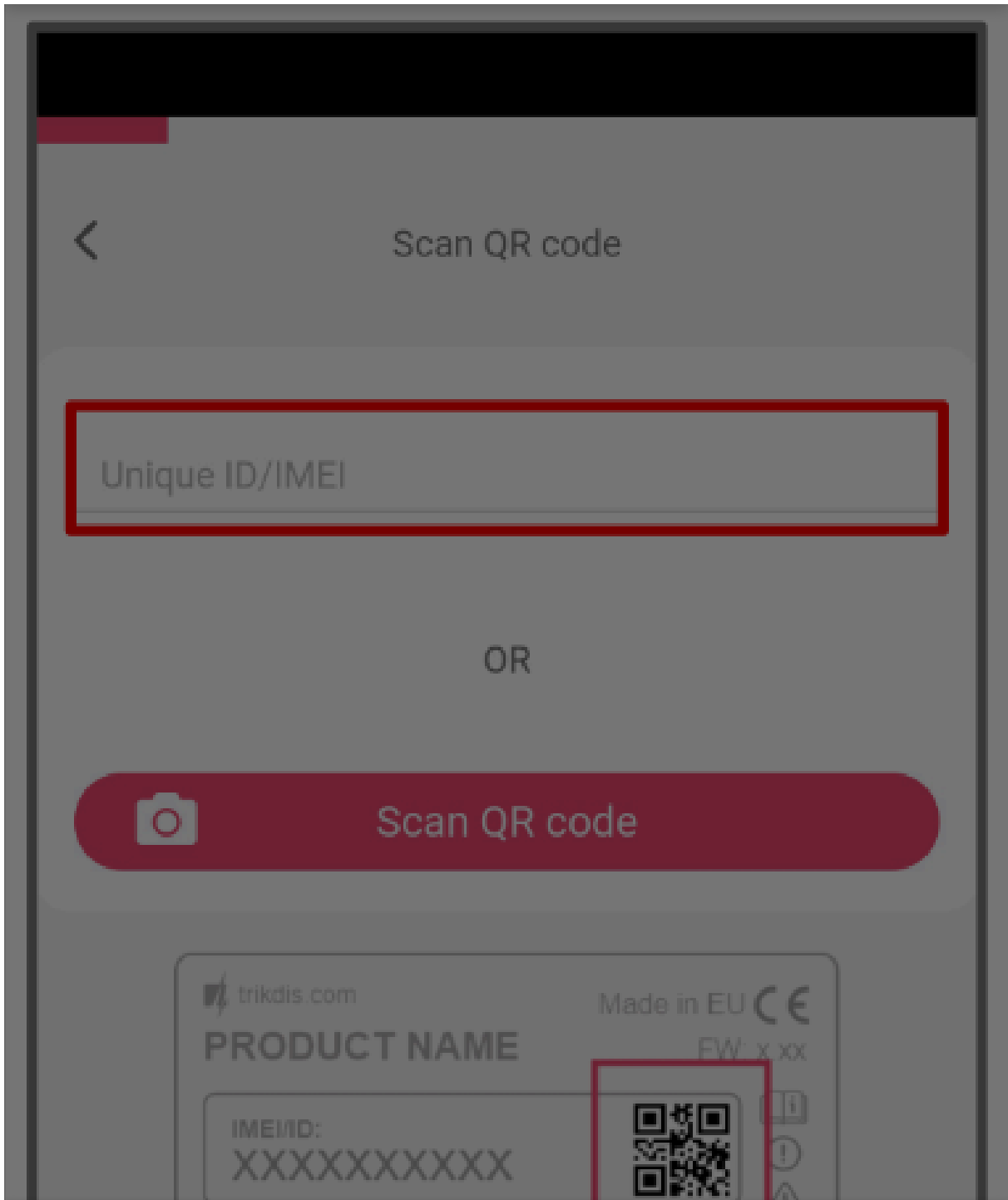

Cookie consent

We use cookies to measure the effectiveness of our documentation and whether users find what they're searching for. With your consent, you're helping us to make our documentation better.

- Google Analytics



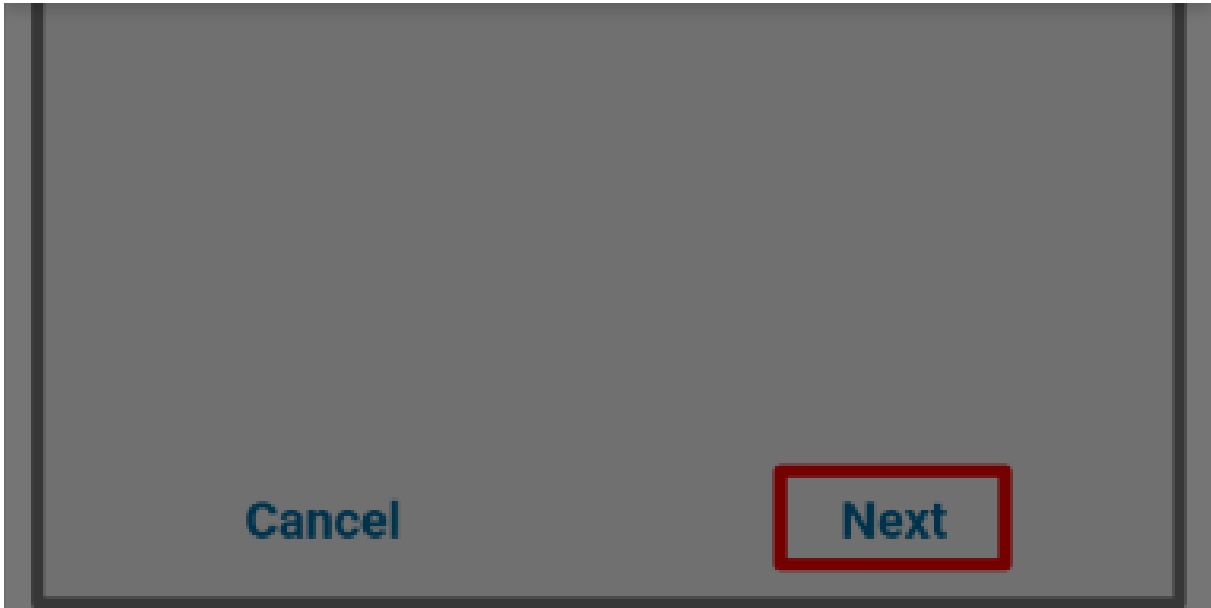

Step 3. Select security company.

Cookie consent

We use cookies to measure the effectiveness of our documentation and whether users find what they're searching for. With your consent, you're helping us to make our documentation better.

Google Analytics

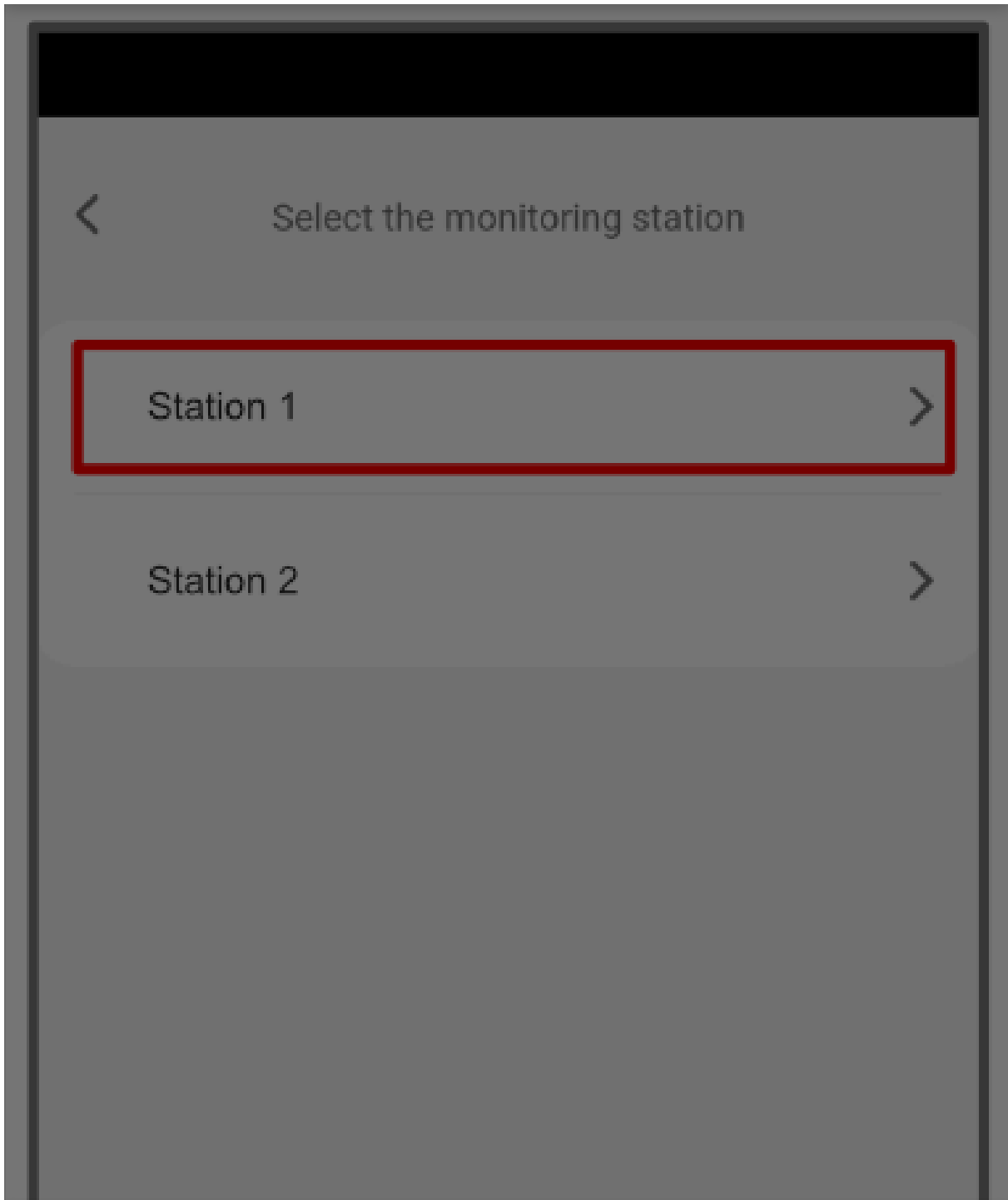

Cookie consent

We use cookies to measure the effectiveness of our documentation and whether users find what they're searching for. With your consent, you're helping us to make our documentation better.

Google Analytics



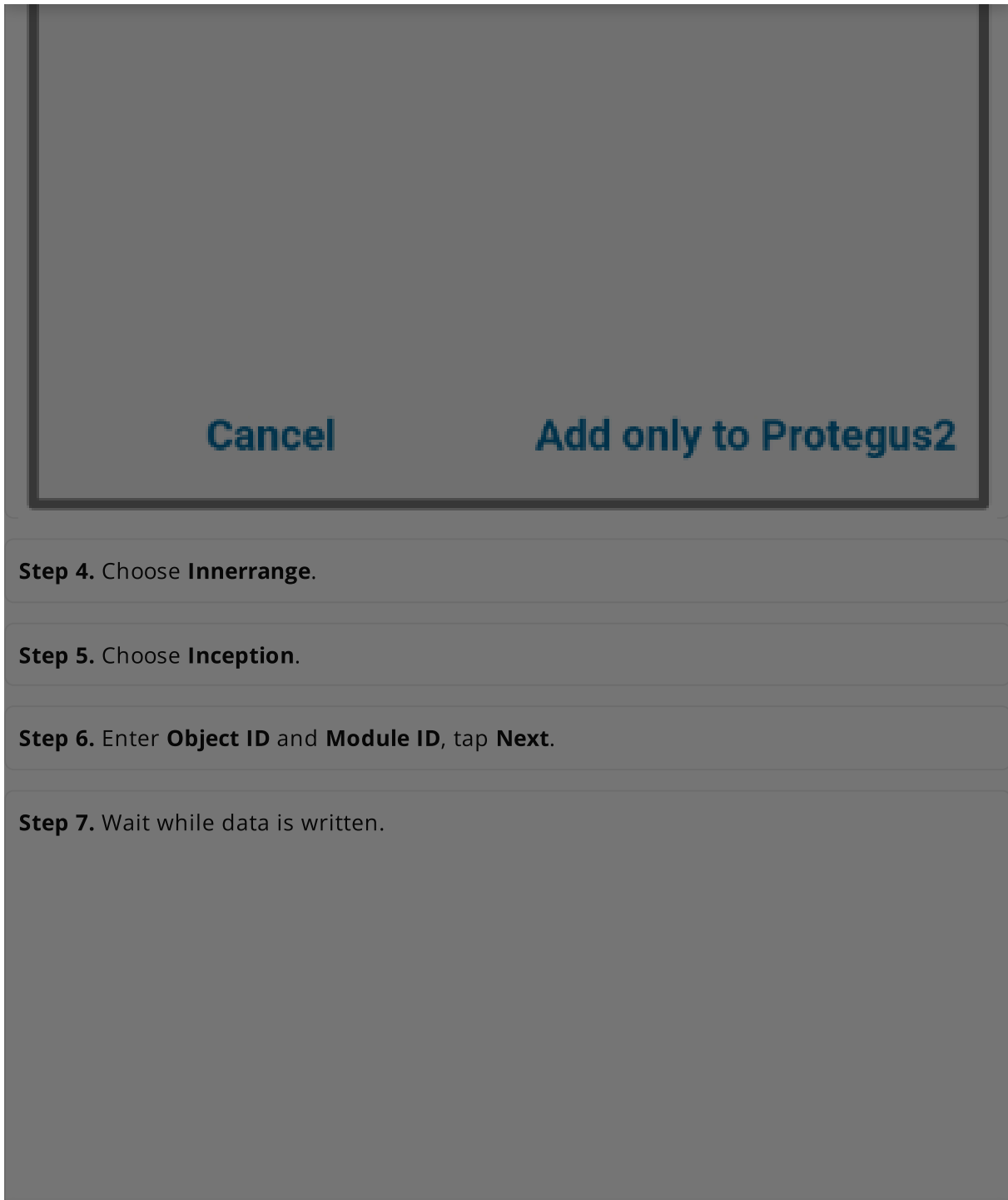

Cookie consent

We use cookies to measure the effectiveness of our documentation and whether users find what they're searching for. With your consent, you're helping us to make our documentation better.

Google Analytics

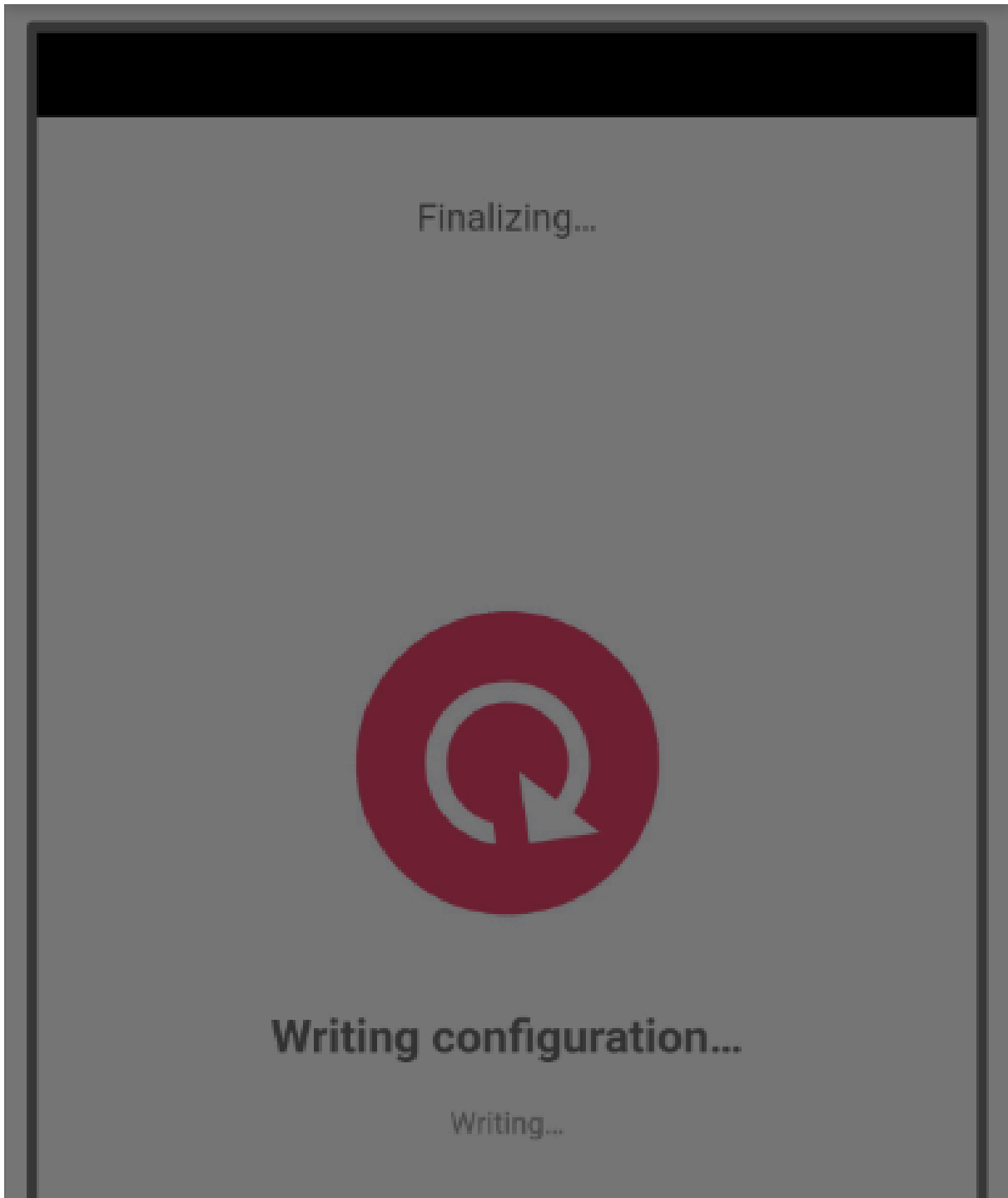

Cookie consent

We use cookies to measure the effectiveness of our documentation and whether users find what they're searching for. With your consent, you're helping us to make our documentation better.

Google Analytics





Cancel

Step 8. Tap Add to Protegus2.

Cookie consent

We use cookies to measure the effectiveness of our documentation and whether users find what they're searching for. With your consent, you're helping us to make our documentation better.

Google Analytics



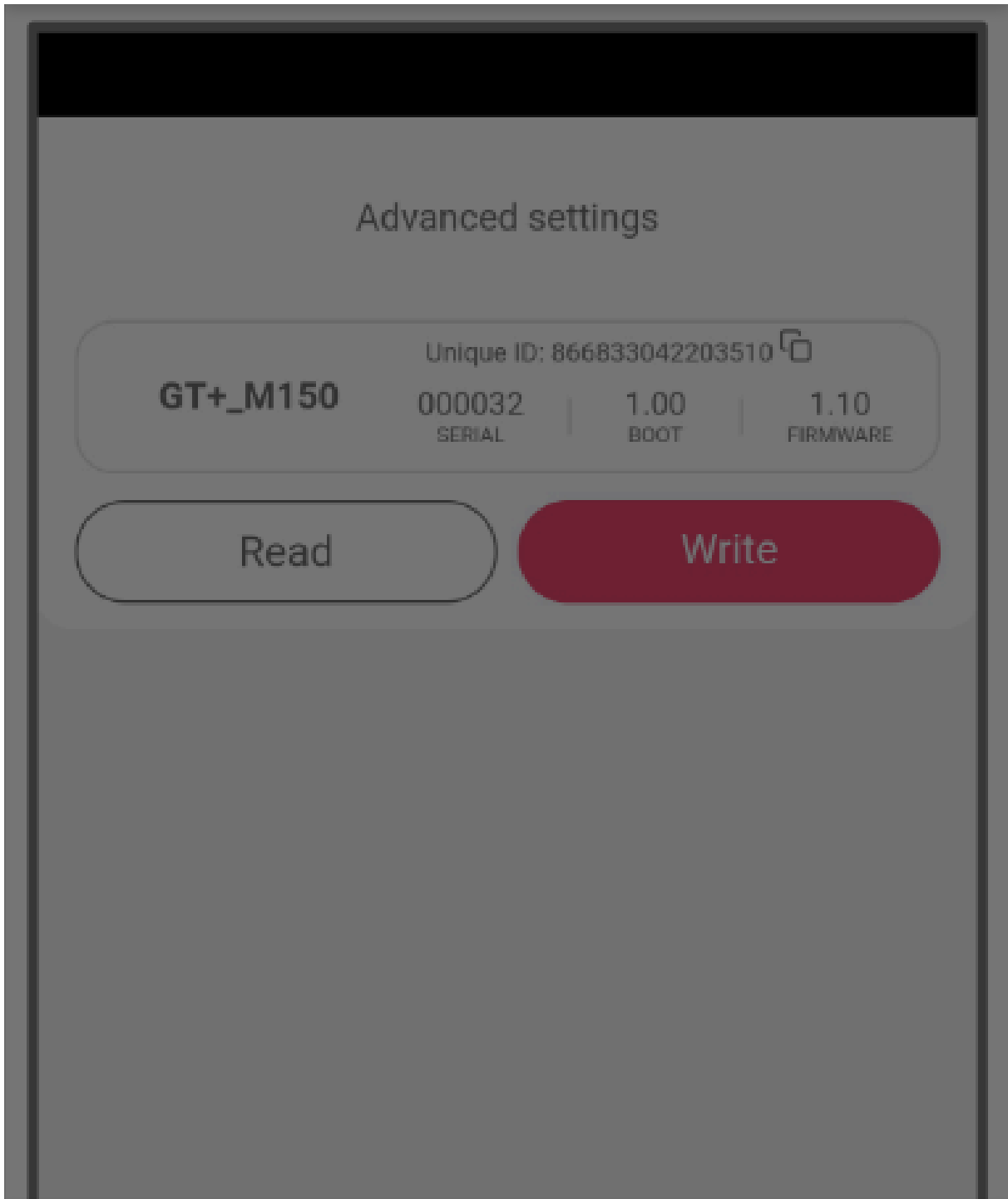

Cookie consent

We use cookies to measure the effectiveness of our documentation and whether users find what they're searching for. With your consent, you're helping us to make our documentation better.

Google Analytics



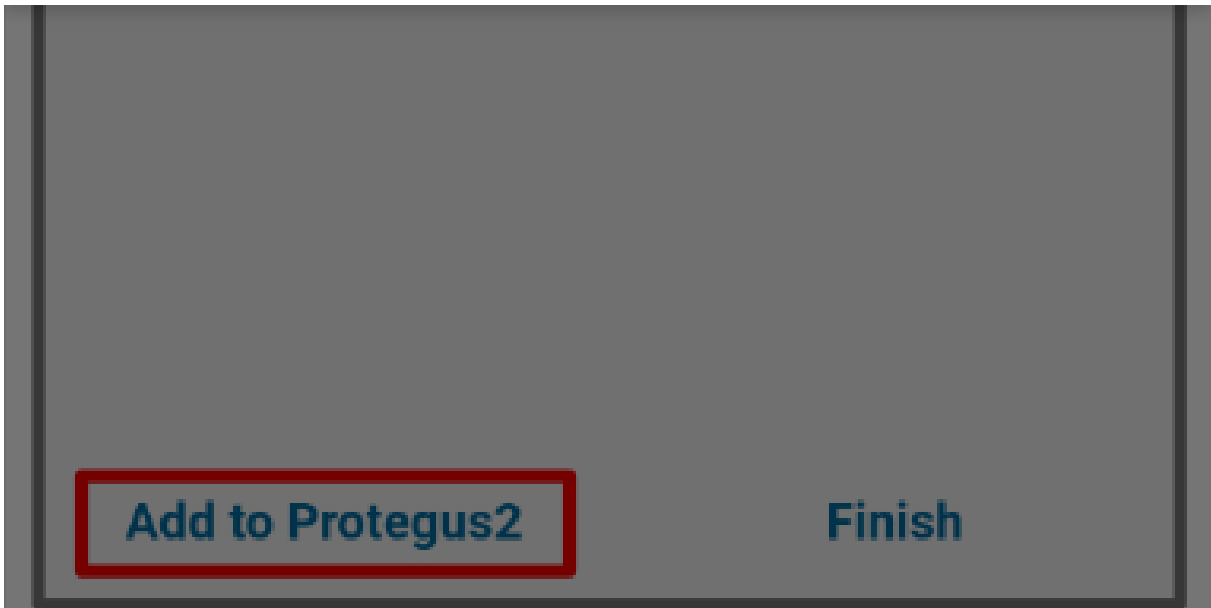

Step 9. Enter system **Name**, tap **Next**.

Cookie consent

We use cookies to measure the effectiveness of our documentation and whether users find what they're searching for. With your consent, you're helping us to make our documentation better.

Google Analytics



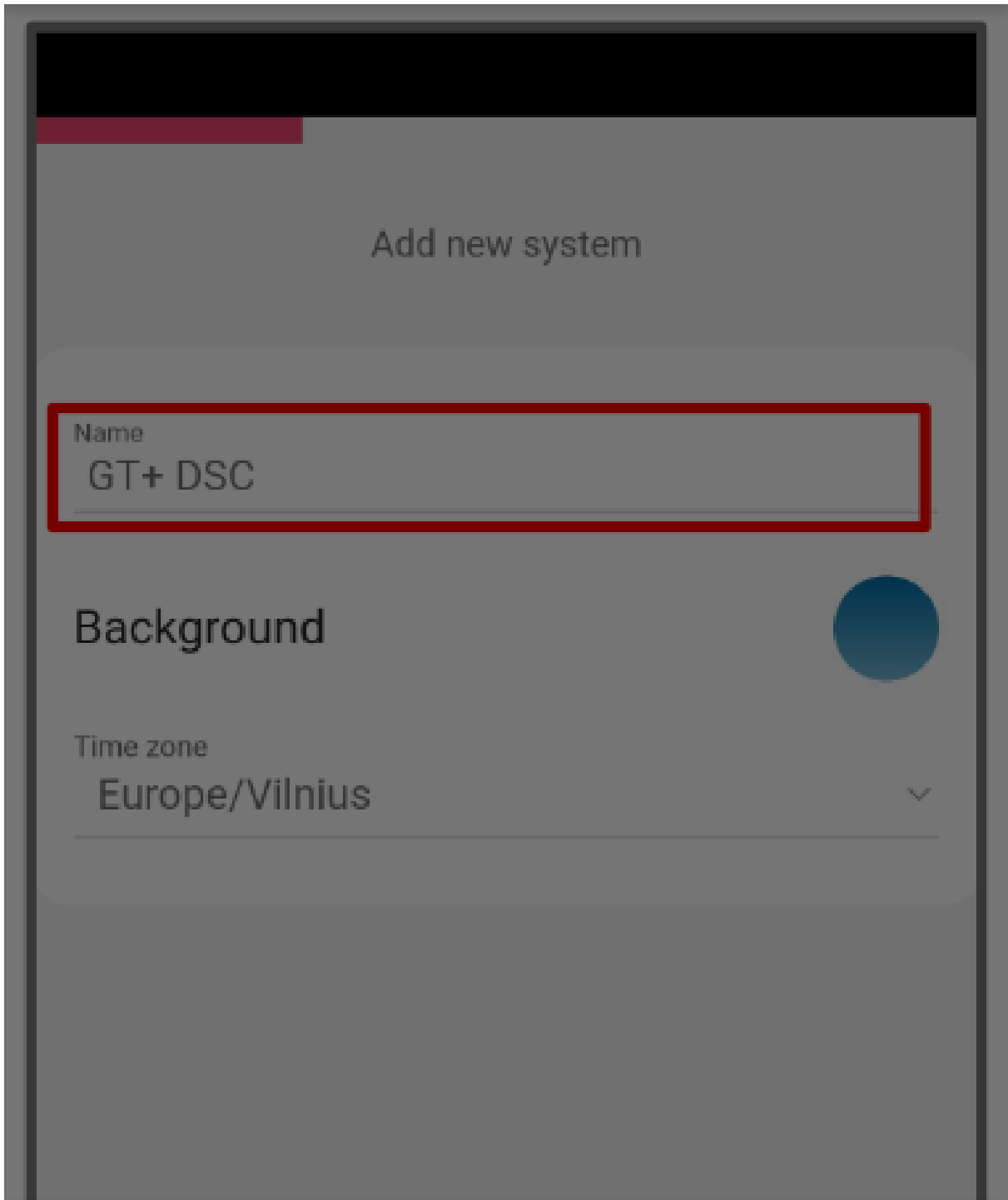

Cookie consent

We use cookies to measure the effectiveness of our documentation and whether users find what they're searching for. With your consent, you're helping us to make our documentation better.

Google Analytics

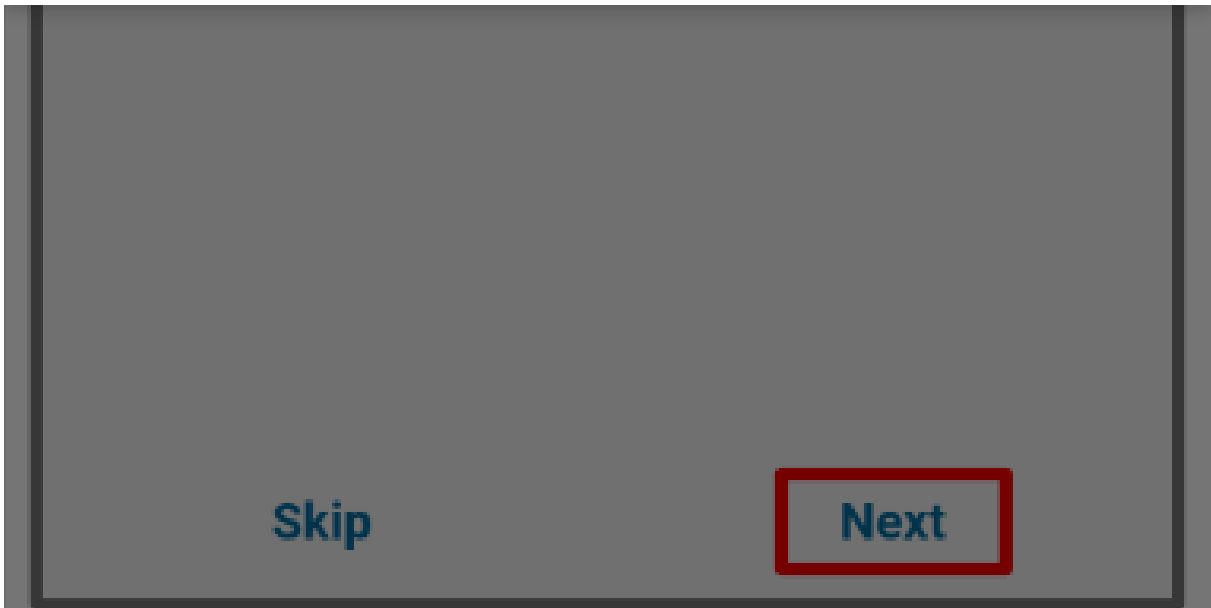

Step 10. Tap **Skip**.

Cookie consent

We use cookies to measure the effectiveness of our documentation and whether users find what they're searching for. With your consent, you're helping us to make our documentation better.

Google Analytics



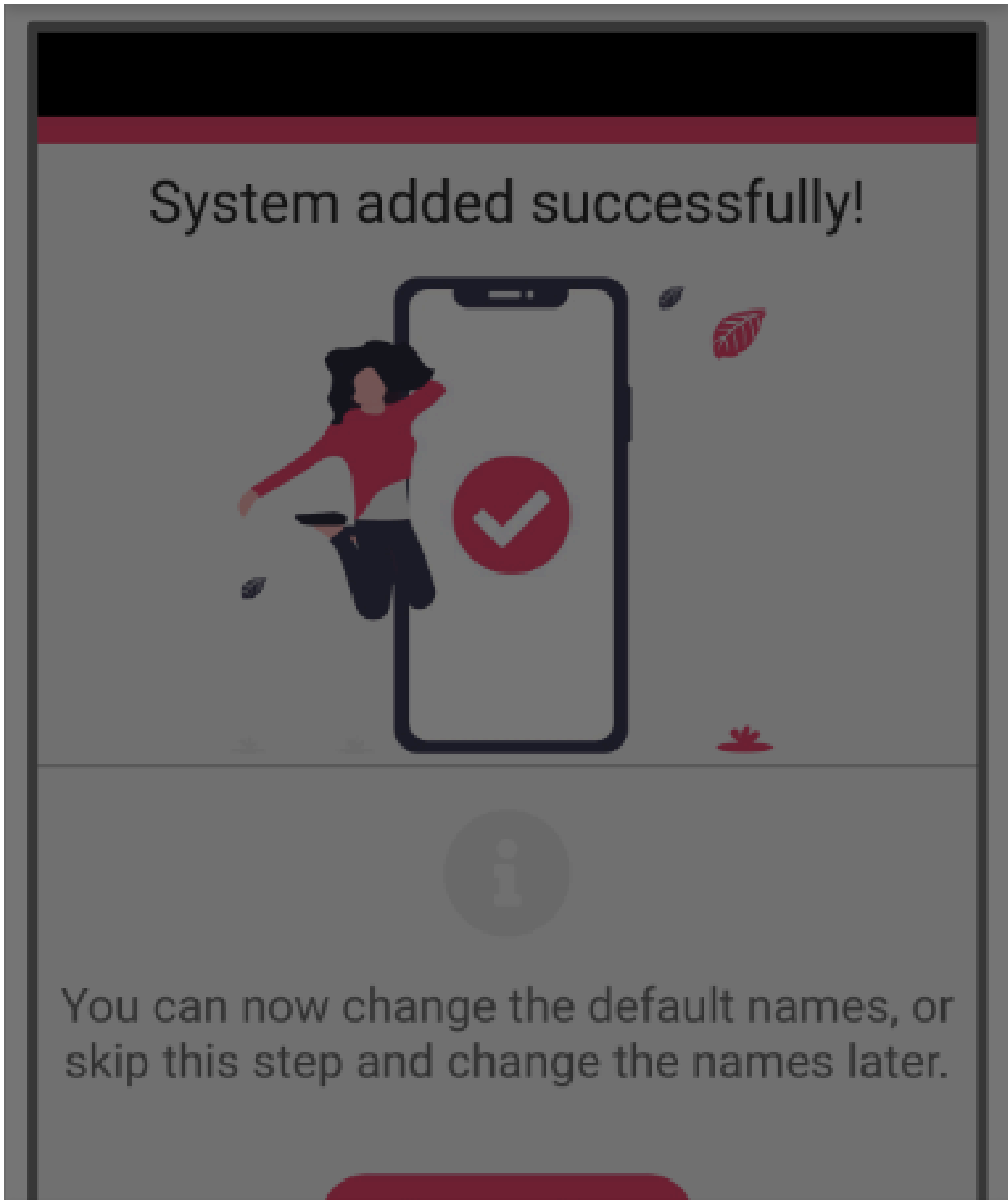

Cookie consent

We use cookies to measure the effectiveness of our documentation and whether users find what they're searching for. With your consent, you're helping us to make our documentation better.

Google Analytics

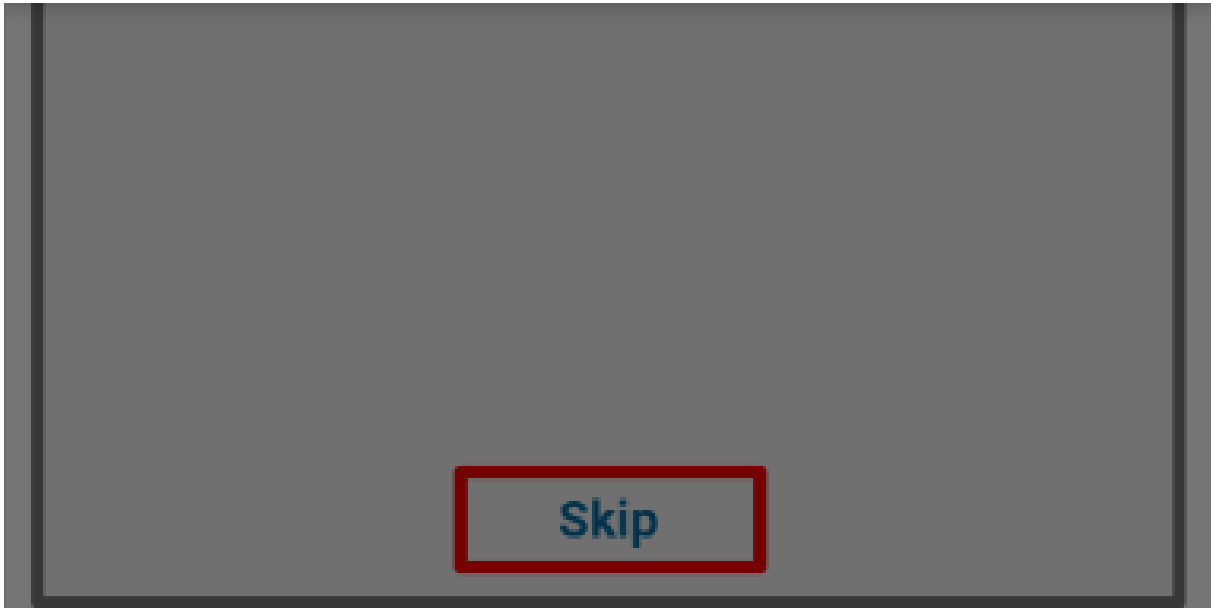

Step 11. Tap on system.

Cookie consent

We use cookies to measure the effectiveness of our documentation and whether users find what they're searching for. With your consent, you're helping us to make our documentation better.

Google Analytics

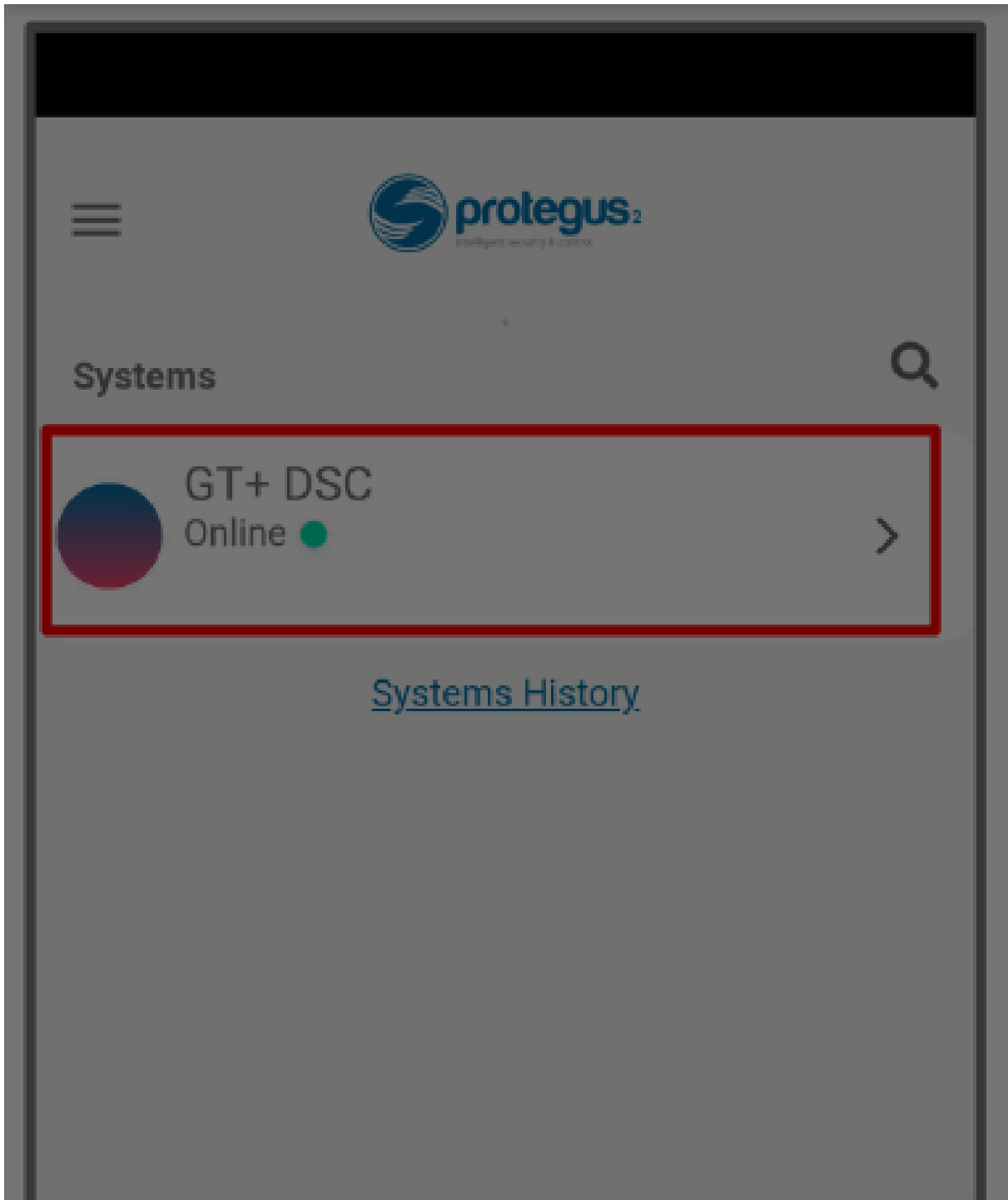

Cookie consent

We use cookies to measure the effectiveness of our documentation and whether users find what they're searching for. With your consent, you're helping us to make our documentation better.

Google Analytics





Step 12. Wait 1 minute for completion and tap **Transfer**.

Cookie consent

We use cookies to measure the effectiveness of our documentation and whether users find what they're searching for. With your consent, you're helping us to make our documentation better.

Google Analytics



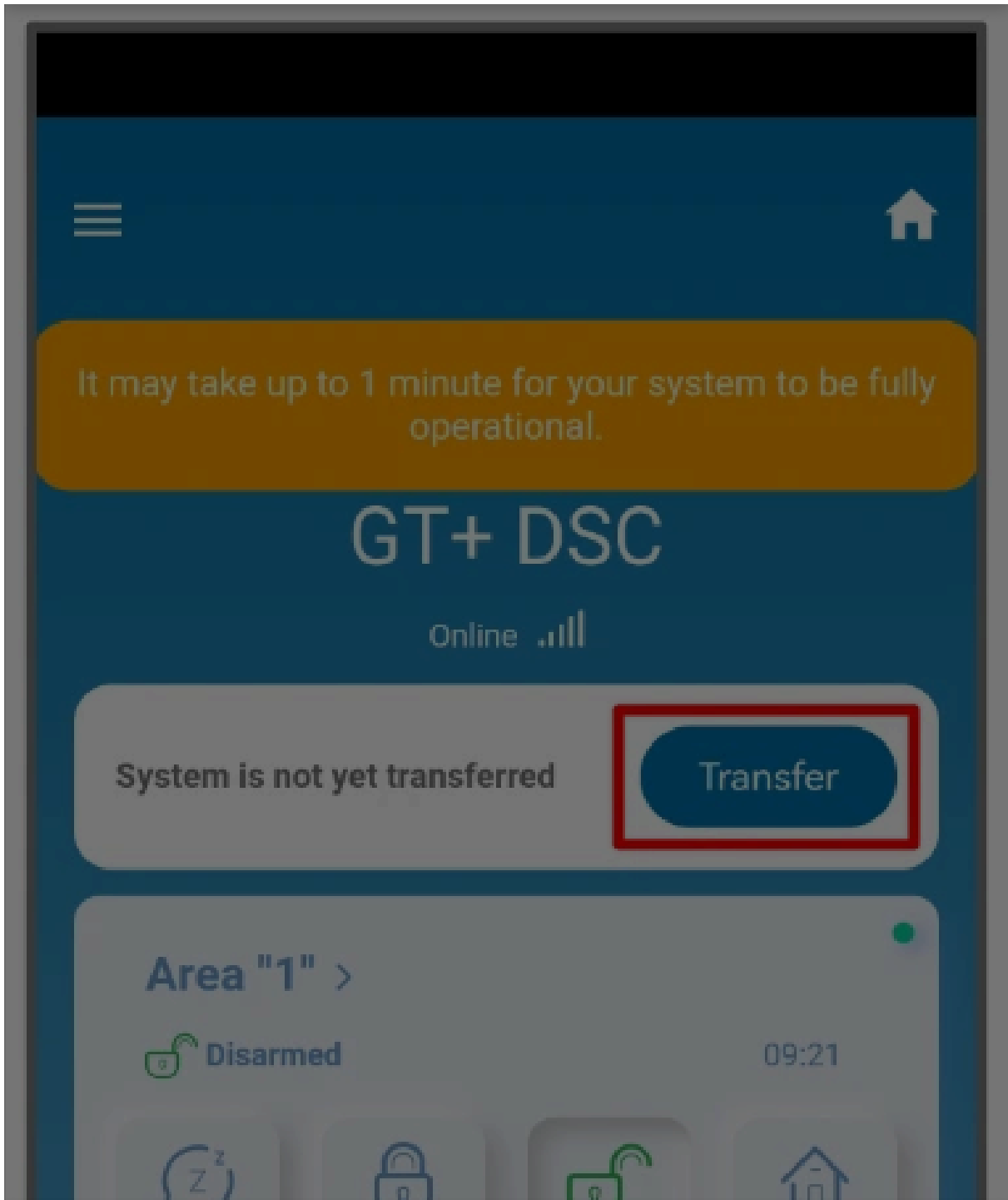

Cookie consent

We use cookies to measure the effectiveness of our documentation and whether users find what they're searching for. With your consent, you're helping us to make our documentation better.

Google Analytics

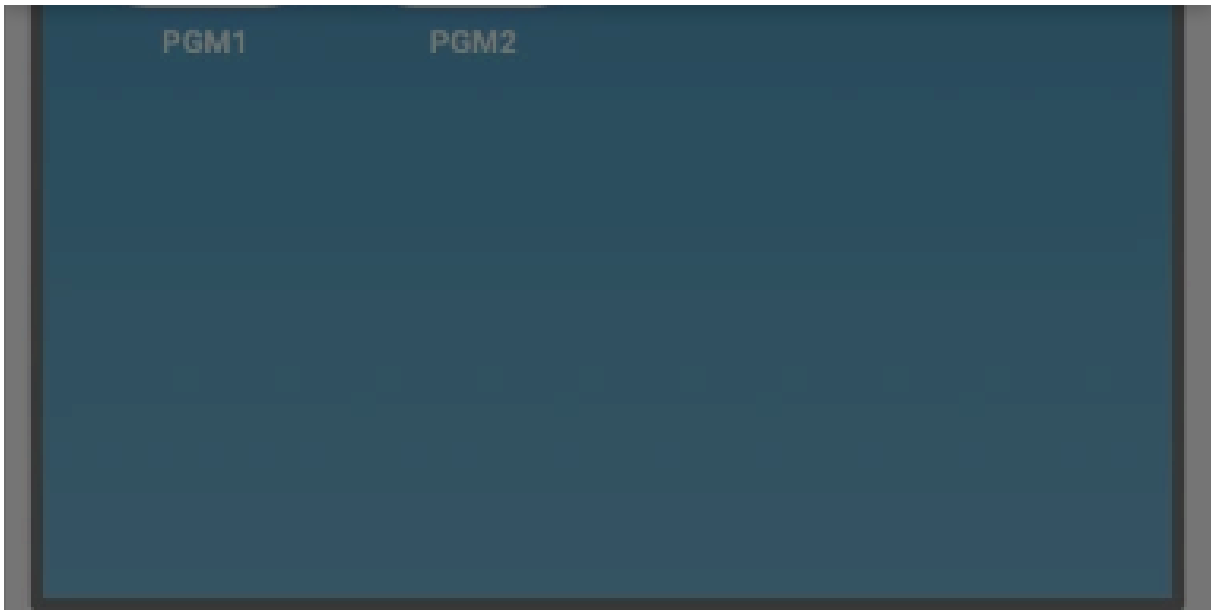

Step 13. Enter the e-mail of the user to whom the installer will transfer the system. Tap **Transfer**.

Cookie consent

We use cookies to measure the effectiveness of our documentation and whether users find what they're searching for. With your consent, you're helping us to make our documentation better.

Google Analytics



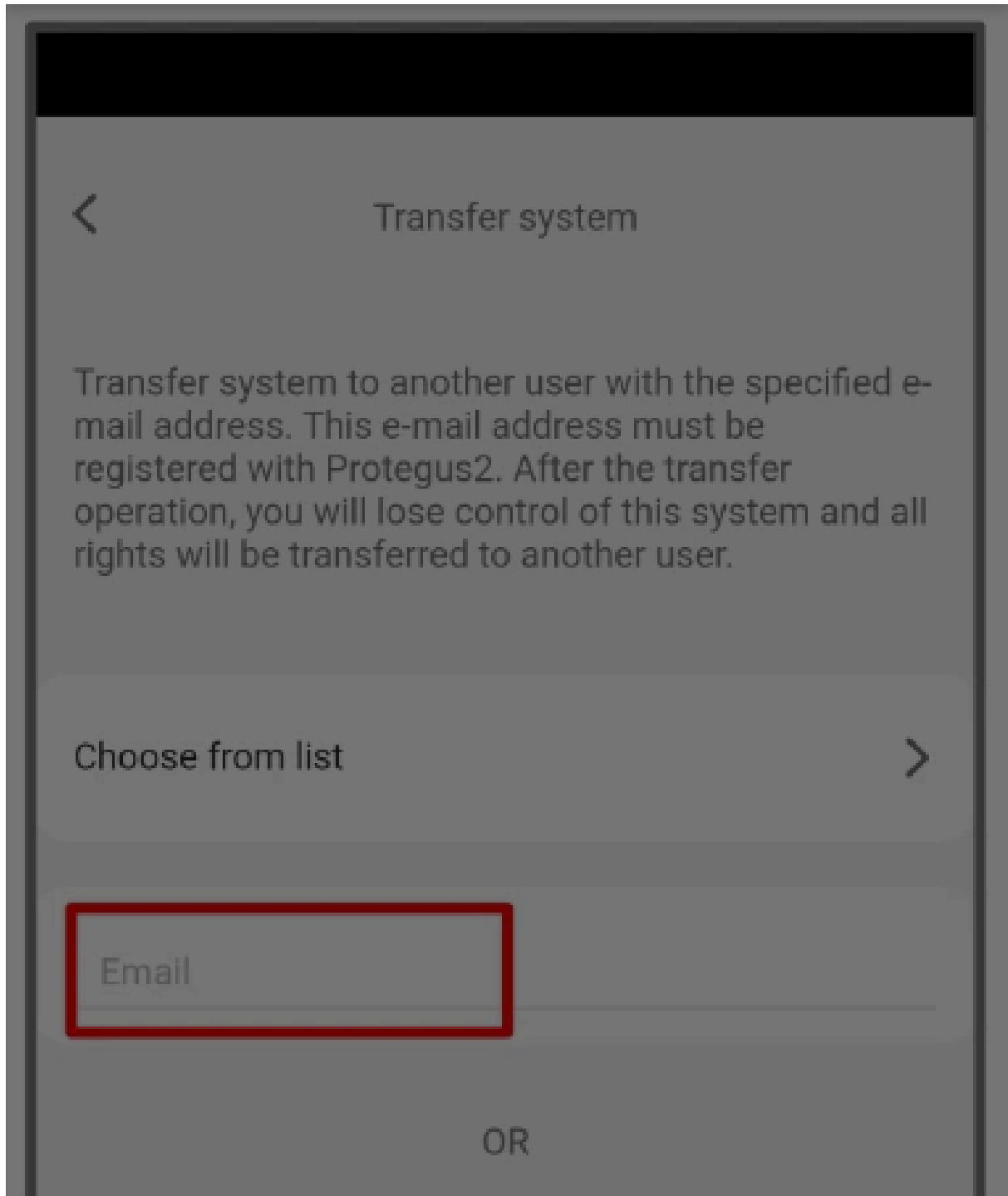

Cookie consent

We use cookies to measure the effectiveness of our documentation and whether users find what they're searching for. With your consent, you're helping us to make our documentation better.

Google Analytics



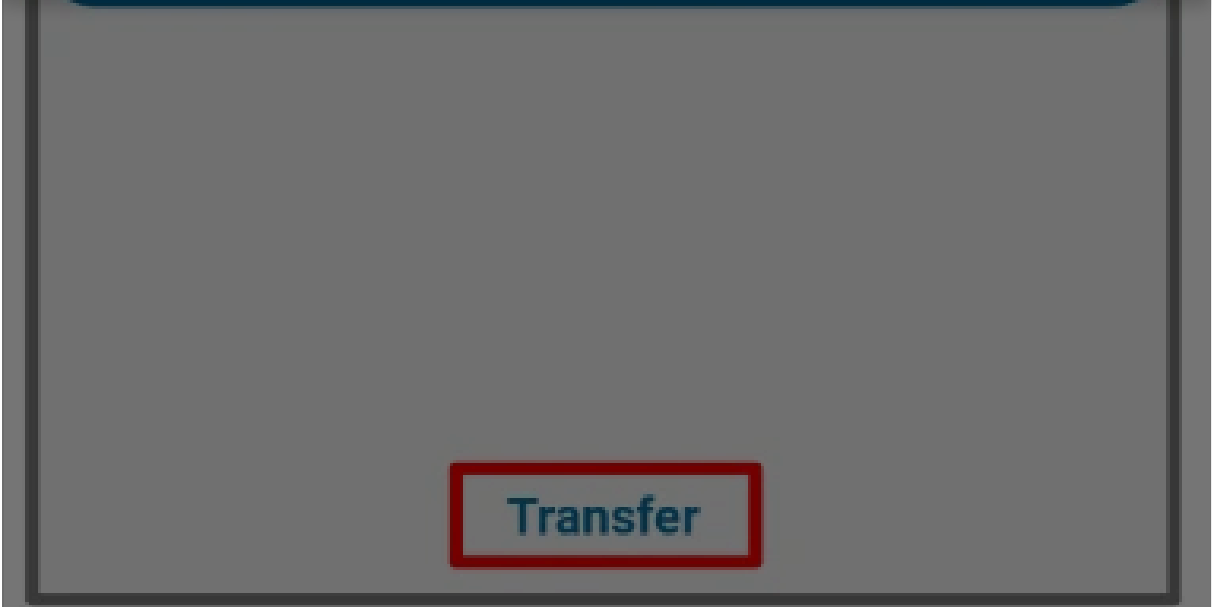

Transfer

Step 14. The system will appear in Protegus on the user's phone.

Cookie consent

We use cookies to measure the effectiveness of our documentation and whether users find what they're searching for. With your consent, you're helping us to make our documentation better.

Google Analytics



Cookie consent

We use cookies to measure the effectiveness of our documentation and whether users find what they're searching for. With your consent, you're helping us to make our documentation better.

Google Analytics



5. System check

TIP

After completing the setup and installation perform a system check:

1. Create an event:

- by arming/disarming the system with the control panel's keypad.
- by triggering a zone alarm when the security system is armed.

2. Make sure that the event arrives to the CMS (Central Monitoring Station) and the Protegus2 app.

Cookie consent

We use cookies to measure the effectiveness of our documentation and whether users find what they're searching for. With your consent, you're helping us to make our documentation better.

- Google Analytics

